



# **Audioscan RM500SL<sup>®</sup>**

## **User's Guide 3.14**

© July 2016

CE 0086

# Table of Contents

1	About RM500SL.....	6
	New in this software release.....	6
	Product description.....	6
	Associated items and supplies.....	6
	SAFETY WARNINGS and NOTICES.....	7
	Environmental safety.....	8
	Declaration of Electromagnetic Compatibility (EMC).....	8
	Warranty, Trademarks, Acknowledgments.....	9
	EC Declaration of Conformity.....	11
	Electronic User's Guide.....	12
	How to Avoid Undesirable Side Effects.....	13
2	Getting Started.....	14
	Unpacking and connecting.....	14
	Microphone connection.....	14
	General care instructions.....	15
	Microphone care.....	16
	Battery pill use and care.....	16
	Mouse, keyboard, barcode scanner.....	17
3	General Operation.....	19
	Input device operation.....	19
	Barcode data input.....	19
	Keypad keys.....	20
	Menus, lists and buttons.....	21
	Screen messages and Help.....	22
	Software updating.....	22
4	General Setup.....	23
	Date and time setup.....	23
	Display settings.....	23
	Saving test setup.....	23
5	Networking.....	25
	Networking requirements.....	25
	Networking setup.....	25
	NOAH Service Port.....	26
	Changing the NOAH service port.....	26
	Testing the NOAH service port.....	27
6	Single computer connection.....	28
	Automatic connection (recommended).....	28
	Static connection.....	28
7	Printing and Storing Results.....	30
	Internal printer paper loading.....	30
	Barcodes, tabular data, headers and comments on printouts.....	31
	Local printer setup.....	31
	Printing to USB memory.....	32
	Network printer setup.....	33
	Printing to a network file.....	33
	Storing and restoring data – setup.....	34
	Storing and restoring data.....	35
	Data storage using NOAH.....	36
8	Test Box Measures - Setup.....	37
	Test box screen.....	37
	Format.....	37
	Scale.....	37
	Hide or Show test box curves.....	37
	2003 or 2009 ANSI standard.....	38
	ANSI test frequencies.....	38
	Test box calibration facts.....	38

Calibrating test box reference microphone.....	39
Calibration check for coupler microphone.....	40
Coupling the hearing instrument for ANSI/IEC tests.....	41
Coupling the hearing instrument for Test box Speechmap.....	41
Positioning the hearing instrument.....	42
9 ANSI/IEC Hearing Aid Tests.....	43
ANSI S3.22-200x facts.....	43
ANSI 2003 and 2009 /IECtests.....	43
ANSI test results.....	43
ANSI input-output curves.....	44
ANSI telecoil terminology.....	45
ANSI telephone simulator (TMFS) test.....	45
Telecoil test results.....	46
10 Other Test Box Measures.....	48
Harmonic distortion.....	48
Noise reduction.....	48
Multicurve procedure.....	49
Multicurve results.....	49
Spectral analysis in Multicurve.....	49
Battery drain test.....	50
Manual control procedure.....	50
Sound level meter using manual control.....	51
11 Sensory loss simulator.....	53
Sensory loss simulator description.....	53
Sensory loss simulator operation.....	53
12 On-Ear Measures - Setup.....	54
On-ear calibration facts.....	54
Calibration of on-ear probe microphone.....	54
Calibration check for probe module.....	55
Max TM SPL setup.....	56
ABR nHL to eHL setup.....	57
Positioning the client.....	57
Positioning the probe tube.....	58
13 On-Ear Measures Screen Setup.....	60
On-ear right or left display.....	60
Graph, table or 2cc target format.....	60
SPL or HL scale.....	60
Hide or show on-ear curves.....	61
14 On-Ear Instrument Measures.....	62
On-ear feedback test.....	62
On-ear noise reduction test.....	62
On-ear manual control.....	63
Sound level meter using on-ear microphones.....	64
15 Occlusion Effect Test.....	65
Occlusion effect measurement.....	65
16 RECD measurement.....	66
Calibration of RECD transducer.....	66
Measure RECD.....	67
RECD results.....	69
ANSI S3.46(2013) RECD.....	70
RECD protocols.....	70
RECD facts.....	72

17	Insertion Gain.....	73
	Insertion gain in SPL.....	73
	Insertion gain in HL.....	74
	Audiometric data entry.....	74
	REUR measurement procedure.....	75
	REAR measurement procedure.....	76
	SII calculation in Insertion gain.....	77
18	Speechmap.....	78
	Speechmap facts.....	78
	DSL 5.0 in Speechmap.....	78
	DSL 5.0 changes.....	79
	NAL-NL1 in Speechmap.....	79
	NAL-NL2 in Speechmap.....	79
	Camfit in Speechmap.....	80
	Using Speechmap.....	80
	Speechmap Setup.....	81
	Screen tour - unaided screen.....	82
	Screen tour - aided screen.....	83
	On-ear or Test box mode.....	83
	SII calculation in Speechmap.....	84
	Using custom stimuli in Speechmap.....	84
	Creating WAV files for Speechmap.....	86
19	Speechmap Fitting Procedures.....	88
	Assessment data entry.....	88
	Assessment data choices.....	89
	Fitting to targets for soft speech.....	90
	Fitting to targets for loud sounds.....	91
	Fitting to targets for mid-level speech.....	91
	Open fittings in Speechmap.....	92
	Verifying Frequency Compression/ Frequency-Lowering Hearing Instruments in Speechmap.....	93
	FM fitting and verification.....	94
20	Speechmap Technical Details.....	96
	Speechmap stimuli.....	96
	Stimulus levels.....	96
	Microphone location effects.....	97
	Deep insertion compensation.....	98
	Speech signal analysis.....	98
21	Troubleshooting.....	99
	Self test failures.....	99
	Initialize Function.....	99
	Test box high distortion or noise.....	100
	Test box curves inconsistent.....	100
	Test box curves differ from specifications.....	100
	Test box speaker overdriven.....	100
	No test box reference mic. detected.....	101
	Invalid test box calibration.....	101
	No on-ear ref. mic. detected.....	101
	Invalid on-ear calibration.....	102
	Invalid RECD transducer coupler calibration.....	102
	Invalid RECD real ear measurement.....	102
	Barcode scanner malfunction.....	102
22	Technical Specifications.....	105

General.....	105
Test box.....	105
On-Ear.....	105
Sensory Loss Simulator.....	106
23 Glossary.....	108
24 References.....	113
25 Appendix 1.....	116
Manufacturer Disclosure Statement for Medical Device Security.....	116
26 Appendix 2.....	119
AudioNote 2.1 VERIFIT and RM500SL Test Signals and Analysis.....	119

# 1 About RM500SL

This section describes the Audioscan RM500SL, provides contact, warranty and trademark information, safety warnings and notices and instructions for accessing the electronic User's Guide.

Note that the User's Guide may be viewed on the RM500SL at any time by pressing <Help> (For long Help pages, use <Left/Right> (or mouse) to switch between the Help index and the Help page and  arrows (or mouse) to scroll through the page).

## New in this software release

Software 3.14 introduces the following significant additions and changes:

1. NAL-NL2 prescription formula. For details, see 17. NAL-NL2 in Speechmap.
2. User-supplied test signals. For details see 17. Using custom stimuli in Speechmap
3. Improved audioscan updater. USB memory sticks left plugged in will not interfere with startup.

## Product description

The RM500SL is a hearing aid analyzer intended to be used by hearing care professionals such as audiologists and hearing aid specialists to verify the electro-acoustic performance of a hearing aid connected to a standard earphone coupler or while worn on the ear of the end user. It consists of:

- a) an integrated acoustically-treated test chamber which houses an optional battery substitute (1.3 volt supply), loudspeaker (which doubles as a sound-field speaker), a reference microphone for controlling the signal from the loudspeaker, and a standardized earphone coupler connected to a measuring microphone for the purpose of measuring the sound level produced in the standard coupler by a hearing aid.
- b) a flat-panel video display, power supply, signal generation, measurement and control electronics and a custom keypad.
- c) a real-ear measurement microphone assembly housing a reference microphone for controlling the signal from the sound-field speaker and a probe microphone connected to a thin silicone tube which may be inserted into the ear canal for the purpose of measuring the sound level in the ear canal produced by a hearing aid.
- d) an optional miniature earphone used to measure the real-ear to coupler difference (RECD) useful in estimating the sound level produced in an individual ear from measurements in the standard earphone coupler.

There is a connector for USB devices (flash drives, a QWERTY keyboard, mouse, printer, barcode scanner), a LAN port, and two auxiliary audio output connectors (not supported in this version of software). Units with serial number below A2051 have an RS232 serial port which is not supported in this version of software.

Electrical supply input requirement: 100 – 240 Vac 47 – 63 Hz 250VA

A hospital grade grounded outlet is required.

## Associated items and supplies

SL-100 RECD Transducer (earphone) for measuring the real-ear to coupler difference

SL-110 Battery substitutes (pills) for measuring battery drain. Set of 4 (1-#10, 1-#312, 1-#13, 1-#675)

VA-120 Barcode scanner for reading barcoded audiometric data on printouts from Audioscan analyzers

VA-131 Microphone extension cable (3') for use with Audioscan analyzers

VA-133 Microphone extension cable (10') for use with Audioscan analyzers

VA-201 NOAH® module allows a networked PC running NOAH to exchange data with Audioscan analyzers

RE201-25 Thermal printer paper for the internal printer in the RM500SL

RE367-36 Probe microphone tubes for single patient use (36 per bag)

## SAFETY WARNINGS and NOTICES

For purposes of IEC 60601-1, this product is Class I with Type BF applied parts. The applied parts are:









1. Probe tube



2. Foam eartip





3. Probe microphone

This device complies with Part 15 of the FCC Rules. Operation is subject to the following two conditions: (1) this device may not cause harmful interference, and (2) this device must accept any interference received, including interference that may cause undesired operation

This Class A digital apparatus complies with Canadian ICES-003

	This symbol on the product is a WARNING describing a foreseen risk
	<b>WARNING:</b> To avoid the risk of electrical shock, use only the power cord supplied with the RM500SL and connect it only to a grounded (protectively earthed) electrical outlet.
	<b>WARNING:</b> To allow electrical power to be rapidly disconnected in the event of an emergency, position the RM500SL in an accessible location so that the power cord may be quickly disconnected.
	<b>WARNING:</b> To avoid the risk of electrical shock, any line-powered peripheral equipment connected to this product must comply with UL/IEC 60601-1 OR comply with UL or IEC and ISO safety standards for such equipment AND a) be operated from an isolating transformer complying with UL/IEC 60601-1 OR b) be kept at least 1.8m (6 ft.) from the patient.
	<b>WARNING:</b> This equipment is not suitable for use in an oxygen-rich environment or in the presence of flammable anesthetic mixtures with air or with oxygen or nitrous oxide.
	<b>WARNING:</b> To ensure proper operation of this product, no modification of this equipment is permitted
	<b>WARNING:</b> Probe tubes are for single-patient use only. Care is required when sliding the probe tube into the ear canal. Be careful not to advance the probe tube further into the ear canal when inserting an earmold or custom hearing instrument into the ear or when inserting the foam tip into the ear
	<b>WARNING:</b> Foam eartips are for single-patient use only
	<b>WARNING:</b> To ensure that the operation of this product is not affected by EMC emissions from other products, this product should not be used adjacent to or stacked on other equipment. If this is necessary, its operation should be verified as normal in this configuration. Portable and mobile RF communications equipment can affect the performance of this product

	<b>WARNING:</b> To reduce the risk of contamination, hearing instruments should be clean before putty is applied and putty should be replaced frequently
	<b>WARNING:</b> The included magnet may effect some medical or electronic devices. Keep magnet at least 5cm (2in.) from implantable devices and other magnetically sensitive devices.
	<b>WARNING:</b> Keep magnet out of reach of children and pets. If a magnet is swallowed seek immediate medical attention.

	This symbol on the product is a <b>WARNING</b> that failure to follow instructions in this part of the User's and/or Quick Start Guides could place the operator or patient at risk.
	Failure to follow the operating instructions for connecting to a network, a local printer, a barcode scanner, or a keyboard, or an external monitor could place the operator at risk
	Failure to follow the operating instructions for connecting the mouse, or the Audioscan update stick could place the operator at risk
	This symbol on the product means that the parts applied to the patient meet the safety requirements of IEC 60601-1 for type BF isolated (floating) applied parts

## Environmental safety

	This symbol on the product means that this product is not to be disposed of in unsorted municipal waste because electrical and electronic waste may contain hazardous substances which could endanger the environment and human health.
This product and its associated items must be disposed of in accordance with local disposal regulations for electrical and electronic waste. Consult your local waste disposal authority regarding applicable regulations.	
The microphone probe tubes and the foam eartips used with the RECD transducer are for single patient use. After use, they may be disposed of in unsorted municipal waste or as required by your facility's waste management policy.	

## Declaration of Electromagnetic Compatibility (EMC)

Medical electrical equipment needs special precautions regarding EMC and needs to be installed and put into service according to the following information:

- The RM500SL should not be used adjacent to or stacked on other equipment. If this is necessary, its operation should be verified as normal in this configuration.
- Portable and mobile RF communications equipment can affect medical electrical equipment and may affect the performance of the RM500SL.
- Performance degradation due to electromagnetic disturbances (including electrostatic discharge) is considered normal and acceptable

The compliances listed in the following table are met with the Audioscan SL-100 RECD transducer connected. The connection of other devices may result in increased emissions.



<b>Guidance and manufacturer's declaration - electromagnetic emissions</b>		
The RM500SL is intended for use in the electromagnetic environment specified below. The user of the RM500SL should assure that it is used in such an environment.		
<b>Emissions test</b>	<b>Compliance</b>	<b>Electromagnetic environment - guidance</b>
RF emissions CISPR 11	Group 1	The RM500SL uses RF energy only for internal function. Therefore RF emissions are very low and not likely to cause any interference in nearby electronic equipment.
RF emissions CISPR 11	Class A	The RM500SL is suitable for use in all establishments other than domestic and those directly connected to the public low-voltage power supply network that supplies buildings used for domestic purposes.
Harmonic emissions IEC 61000-3-2	Class A	
Voltage fluctuations/ flicker emissions IEC 61000-3-3	Complies	

## Warranty, Trademarks, Acknowledgments

The Audioscan RM500SL is manufactured by Etymonic Design Inc., 20 Ludwig St., Dorchester, Ontario, Canada, N0L 1G4. Web site [www.audioscan.com](http://www.audioscan.com).

**Phone:** 800-265-2093 (USA only); 519-268-3313 **Fax:** 519-268-3256

**Email:** [info@audioscan.com](mailto:info@audioscan.com) or [service@audioscan.com](mailto:service@audioscan.com)

The authorized representative for this product in the European Community is:

P.C. Werth, Audiology House, 45 Nightingale Lane, London, UK, SW12 8SP.

Phone: +44 (0) 181-675 5151 Fax +44 (0) 181-675 7577.

**Warranty:** The RM500SL is warranted against defects for two years from date of purchase. Within this period, it will be repaired without charge for parts, labor or return shipping when returned prepaid to your authorized Audioscan service agent. This warranty does not apply to equipment that, in our sole judgment, has been subject to misuse, or unauthorized alteration or repair.

This warranty does not apply to battery substitutes (pills), which carry a 90 day warranty. This warranty does not cover battery substitutes used in a hearing aid manufacturing facility.

### Trademarks:

Audioscan, Axiom, Speechmap, Verifit and Viewport, are registered trademarks of Etymonic Design Inc. DSL is a registered trademark of the University of Western Ontario. All rights reserved. HP LASERJET is a registered trademark of Hewlett-Packard Company. NOAH is a registered trademark of the Hearing Instrument Manufacturer's Software Association. QUEST is a trademark of Quest Technologies Inc. PostScript is a registered trademark of Adobe Systems, Inc.

### Acknowledgments:

DSL 5.0 is used under license from the University of Western Ontario (UWO) which is solely responsible for its content. We acknowledge the support received from past and present staff at the National Centre for Audiology

at UWO in implementing the DSL method.

CAMFIT is used under license from Prof. Brian C.J. Moore, University of Cambridge, UK. We are indebted to the University of Memphis Hearing Aid Research Laboratory for permission to use some of their recorded speech material.

NAL-NL1 is used under license from the National Acoustics Laboratories, Australia.

NAL-NL2 is used under license from Hearworks Pty Ltd, Australia.

**Software licenses:**

Audioscan distributes selected software components under various open source licenses. These licenses generally give you the right to copy and change the affected component's software source code. For details, see the license files distributed with the software, or contact Audioscan.

## EC Declaration of Conformity



### EC Declaration of Conformity

**Manufacturer:** Etymonic Design Incorporated (operating as Audioscan)  
20 Ludwig Street  
Ontario, N0L 1G4  
CANADA

**European Authorized Representative:** PC Werth Ltd.  
Audiology House  
45 Nightingale Lane  
London SW 12 8SP  
UK

**CE-marked Products:** Model Verifit VF-2, Real-Ear Hearing Aid Analyzer (Commencing with Serial Number C0900)  
Model RM500SL, Real-Ear Hearing Aid Analyzer (Commencing with Serial Number A1715)  
Model Axiom, Real-Ear Hearing Aid Analyzer (Commencing with Serial Number B1000)  
Model Verifit VF-1, Real-Ear Hearing Aid Analyzer (Commencing with Serial Number 3879)

**Products Classification:** Class IIa, after MDD Annex IX, Rule 5

**Certification:** EC Certificate CE 543241 issued by the British Standards Institution for compliance with Annex V, section 3.2 of European Union Council Directive **93/42 EEC**, as amended by Directive **2007/47/EC**, concerning medical devices.

**Declaration:** We hereby declare that the above mentioned devices comply with the legislation regulating medical devices in the United Kingdom transposing European Medical Devices Directive 93/42/EEC, namely Statutory Instruments 2002 No. 618 (Consolidated legislation), and the Medical Devices (Amendment) Regulations 2008 No. 2936 which transpose Directive 2007/47/EC into UK law

Further, we also declare that Verifit VF-2, commencing with Serial Number C1267, and Axiom, commencing with Serial Number B1954, comply with the legislation regulating certain hazardous substances in electrical and electronic products in the United Kingdom, transposing the provisions of the European Parliament and Council Directive 2011/65/EU ("RoHS2"), namely the Restriction of the Use of Certain Hazardous Substances in Electrical and Electronic Equipment Regulations 2012 (SI 2012 No. 3032) as amended ("the RoHS Regulations 2012")

**Date of Validity:** April 15, 2015

D. B. Whitred   
Regulatory Affairs Manager,  
Quality System Management Representative



20 Ludwig Street, Dorchester, Ontario, N0L 1G4 • www.audioscan.com • Tel: (519)268-3313 / Fax: (519)268-3256 / USA 1-800-265-2093

## Electronic User's Guide



Failure to follow operating instructions could place the user or operator at risk.

A printable User's Guide is on the system USB flash drive which contains the operating software. This User's Guide will be updated each time you download new software from [www.audioscan.com](http://www.audioscan.com) to the system USB flash drive. Except for some additional reference material, this same information is available to you at any time by selecting Help on the RM500SL. A .pdf file viewer, such as Acrobat Reader (5.0 or higher) or Foxit Reader is required to view the User's Guide.

The system USB flash drive is located in the test chamber under the printer paper roll cradle.

To view the User's Guide:

5. Turn the RM500SL off, open the test chamber and remove the foam from the test chamber floor.
6. Gently remove the system USB flash drive from the USB port.

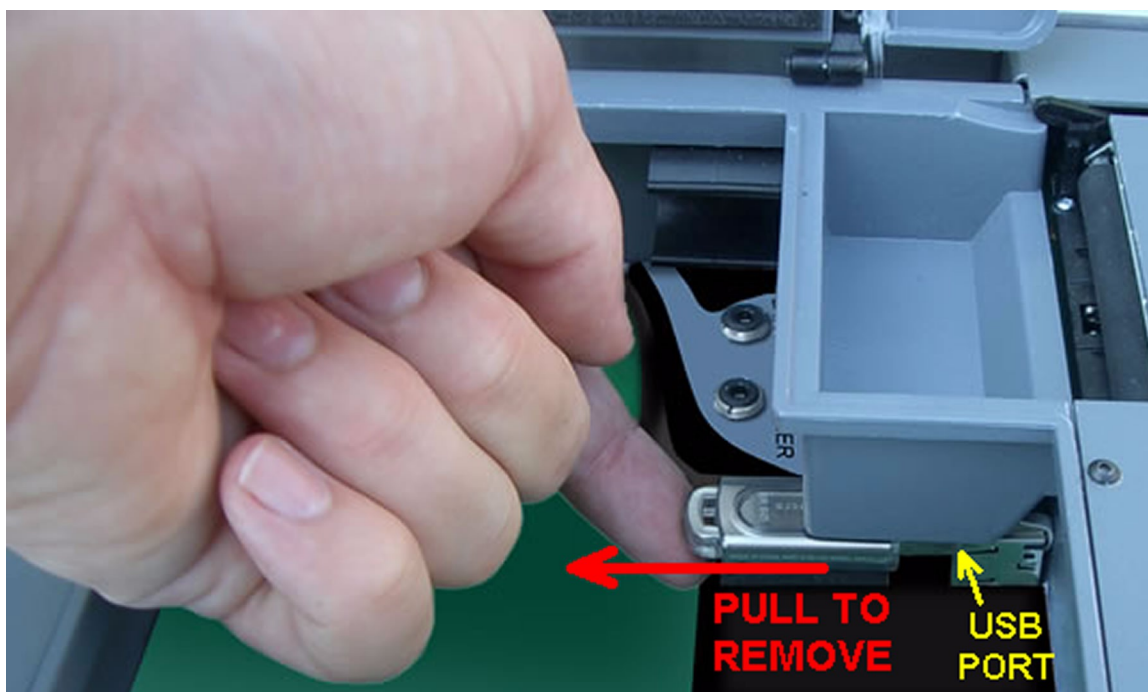

7. Insert the system USB flash drive into a USB port on your PC.
8. If your PC does not open the flash drive automatically, select My Computer, then the Removable Disk drive..
9. Double click the User\_Guide folder to open it.
10. Double click the *english* folder and copy the RM500SL Users Guide.pdf file to an appropriate location on your PC. Double click on the file to open it for viewing.
11. When you have finished copying the file from the USB flash drive, click on the *safely remove* icon on your PC and remove the flash drive when you are notified that it is safe to do so.
12. Reinstall the USB flash drive in the RM500SL making sure it is correctly and firmly in place.

## How to Avoid Undesirable Side Effects

During the development of the hearing aid analyzer, Audioscan performed a rigorous Risk Assessment to identify any undesirable side effects that a user could be exposed to during the use of the RM500SL, and incorporated numerous risk reduction design elements into the RM500SL to minimize the risk to users and patients.

Following are the actions which a user should take to ensure that these risk control measures continue to be effective

### **Loud Sounds:**

The RM500SL is designed to produce sound pressure levels as high as 85 dB at the probe reference microphone. Exposure to these levels for more than 7 hours can produce hearing damage. When such levels are amplified by a hearing aid, the level in the ear canal will be determined by the settings of the hearing aid but may reach levels that can produce hearing damage in less than 30 seconds. To avoid this possibility,

1. hearing aids should be adjusted to limit sound pressure levels to safe levels
2. the maximum TM SPL setting (see Max TM SPL Setup) should be used to terminate tests if an unsafe level is detected in the ear canal
3. test levels should be limited to 70 dB SPL except when necessary to verify the limiting levels of the hearing aid, in which case, the test should not last longer than 15 seconds
4. be aware of the test signal and patient reaction during a test and be prepared to respond to any sign of discomfort by reducing the SPL setting, switching off the equipment or the hearing aid, or removing the patient from the area.

When using the equipment to measure the Real-Ear to Coupler Difference in small ear canals, it is possible to induce a hearing loss if the test is allowed to continue for more than 1 hour. Since accurate results can be obtained in less than 10 seconds, this possibility should never occur in normal practice.

### **Power and Grounding:**

This product contains numerous safety features to ensure that the probability of electrical shock is as low as reasonably practicable. In order to ensure that all of the safety features work optimally you must ensure that the power cord is plugged into a grounded outlet. Any line-powered peripherals connected to the RM500SL must comply with UL/IEC 60601-1 OR comply with UL or IEC or ISO safety standards for such equipment, AND a) be operated from an isolating transformer complying with UL/IEC 60601-1, OR b) be kept at least 6 feet (1.8m) from the patient.

### **Ear Infection:**

Probe tubes or RECD foam tips should not be re-used on another patient. There is a possibility of transferring an ear infection to the other patient. Probe tubes and RECD foam tips are for single-patient use only. Do not attempt to clean or re-use.



### **Ear Canal Discomfort:**

An otoscopic examination should always be performed prior to inserting a probe tube into the ear canal to ensure that it is healthy and free of obstructions. Care is needed when inserting probe tubes into the ear canal. Although the probe tubes are made of soft, flexible material specially designed for this application, it is possible to scrape the ear canal or touch the eardrum causing brief discomfort. You should carefully follow the instructions in "Positioning the probe tube" section of this User's Guide.

## 2 Getting Started

This section provides instructions for unpacking the RM500SL and connecting various components and associated items. Note that battery pills (SL-110), the RECD transducer (SL-100), the barcode scanner (VA-120) and a microphone extension cable (VA-131, VA133) are associated items which must be ordered separately.

### Unpacking and connecting

	<p><b>WARNING:</b> To avoid the risk of electrical shock, use only the power cord supplied with the RM500SL and connect it only to a grounded (protectively earthed) electrical outlet.</p> <p><b>WARNING:</b> To allow electrical power to be rapidly disconnected in the event of an emergency, position the RM500SL in an accessible location so that the power cord may be quickly disconnected.</p> <p><b>WARNING:</b> To ensure that the operation of this product is not affected by EMC emissions from other products, this product should not be used adjacent to or stacked on other equipment. If this is necessary, its operation should be verified as normal in this configuration. Portable and mobile RF communications equipment can affect the performance of this product</p>
	<p>Failure to follow operating instructions could place the user or operator at risk.</p>

1. Carefully unpack the RM500SL and check the contents of the shipping box against the enclosed packing list. Note that some parts may be packed inside the test chamber.



2. Unwrap the power cord from its stowage hooks - noting carefully how it has been packed. To avoid serious damage to the display screen, always repack the cord this way.
3. Connect the power cord to the socket next to the power switch on the right side of the unit. Plug the other end into a grounded 100 – 240 volt power outlet.

### Microphone connection

1. Plug the reference microphone and the coupler microphone into the connectors in the test chamber as shown.

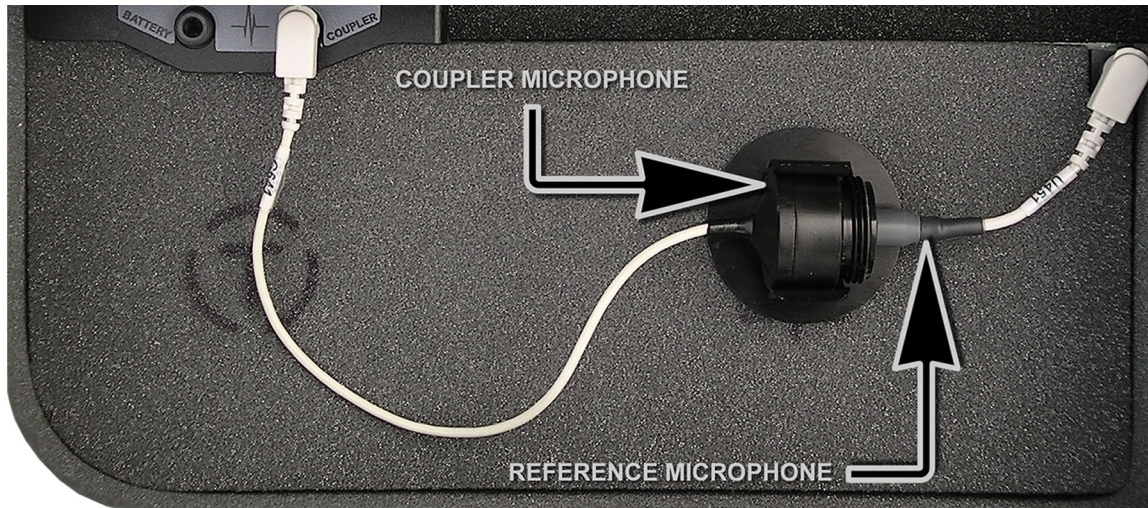

2. Plug the probe microphone assembly into the probe connector located at the left of the test chamber as shown.

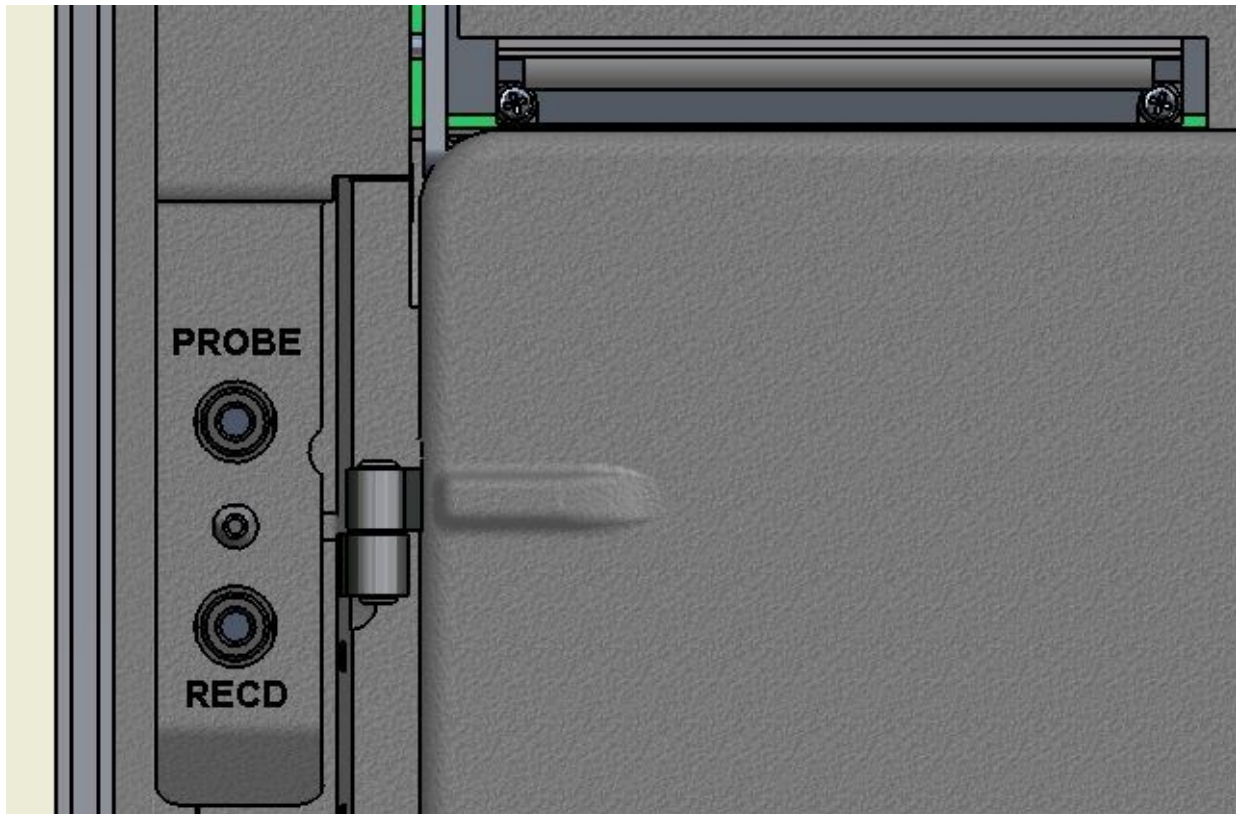

**NOTE:** A microphone extension cable (VA-131, 133) is available from Audioscan. Standard audio extension cables should not be used. They will substantially increase noise levels.

## General care instructions

Probe tubes are for single patient use only. They may be wiped with alcohol wipes for re-use with the same

patient, but must not be used with multiple patients. Attempts at ultrasonic cleaning usually result in cerumen becoming lodged in the lateral end which causes irreparable damage to the probe microphones.

The case can normally be cleaned/dusted with a damp cloth, however if it is soiled we recommend wiping with a mild solution of water and detergent, or with alcohol-impregnated wipes deemed safe for use on electronic equipment. Parts that come into contact with patients (the probe module body, cable, and blue lanyard) should be regularly wiped down with alcohol wipes.

Hearing instruments should be cleaned prior to introduction to the test chamber due to the difficulty of sanitizing the acoustic foam. Custom hearing instruments must be cleaned with disinfectant towlettes (i.e. audiowipes) prior to placing in the test for this reason and to minimize contamination of the blue putty used with the HA-1 coupler. The acoustic foam in the floor of the test chamber is easily removed and should be replaced if badly worn or soiled.

Audioscan recommends periodic replacement of the blue putty used with the HA-1 coupler to ensure cleanliness. Both couplers and coupler mic can be wiped down with alcohol wipes as needed.

Ensure that all safety and usage recommendations on cleaning product packages are followed.

## Microphone care

### Coupler microphone:

1. **DO NOT** twist the cable when attaching a coupler to the coupler microphone. Turn only the coupler or unplug the coupler microphone before turning it.
2. **DO NOT** leave the coupler microphone plugged in when transporting.
3. **DO** make sure that the 2cc coupler is tightly screwed to the coupler microphone when performing hearing instrument tests. Coupler leakage can cause feedback and erratic response curves.
4. **DO** make sure the tubing on the BTE (HA-2) coupler is free from any cracks/tears.
5. **DO** make sure that any replacement tubing used on the BTE coupler is either obtained from Audioscan, or is #13 heavy wall earmold tubing exactly 10 mm in length.

### Probe microphone:

Debris can alter the probe module reference microphone calibration and frequency response and can permanently clog the probe module port.

1. **DO NOT** reuse probe tubes. Probe tubes can be wiped with alcohol wipes for re-use with the same patient, but must not be used with multiple patients. Attempts at ultrasonic cleaning usually result in cerumen becoming lodged in the lateral end which causes irreparable damage to the probe microphones.
2. **DO NOT** attempt to open or repair the probe microphone. Attempting to repair the probe module may lead to damage or alteration of the factory calibration.
3. **DO** keep the probe module and probe tubes in a clean area.
4. **DO** stow the probe module when not in use or when transporting the RM500SL.

## Battery pill use and care



*Battery pills are optional.* The thin connecting strip of each battery pill is **fragile**. When inserting pills into hearing instrument battery compartments, take care that this strip is not pinched or bent severely as the battery door is closed.

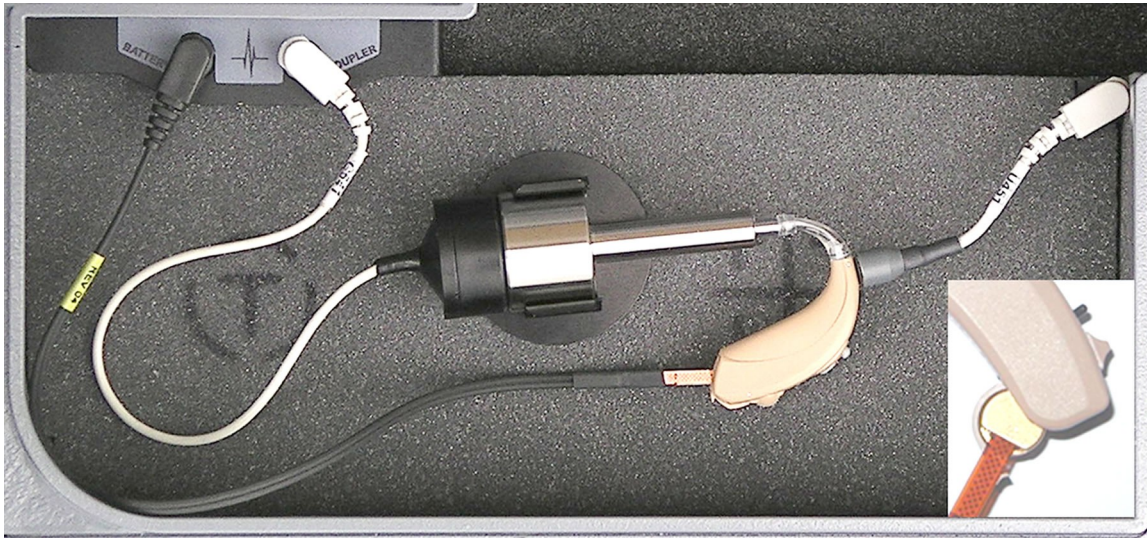

1. Select a battery pill that is appropriately sized for the hearing instrument that you are testing.
2. Insert the pill into the hearing instrument, carefully closing the battery door over the thin connecting strip.
3. Plug the pill's cable into the battery pill jack inside the RM500SL Test box. (to the left of the coupler microphone connection).
4. Turn the hearing instrument on.



## Mouse, keyboard, barcode scanner

	<p><b>WARNING:</b> To avoid the risk of electrical shock, any line-powered peripheral equipment connected to this product must comply with UL/IEC 60601-1 OR comply with UL or IEC and ISO safety standards for such equipment AND a) be operated from an isolating transformer complying with UL/IEC 6061-1 OR b) be kept at least 6 feet (1.8 m) from the patient.</p>
	<p>Failure to follow operating instructions could place the user or operator at risk.</p>

The RM500SL may be operated from the built-in keypad, a USB mouse (not included) or a standard USB computer (QWERTY) keyboard (not included), which may also be used to enter headers and comments on printouts: See Input device operation.

An optional barcode scanner may be connected to the USB port to enter threshold, UCL and RECD data directly from Audioscan printouts. Barcoded threshold data printed by some Grason-Stadler audiometric equipment may also be scanned. Scanners other than that supplied by Audioscan may not work and are not supported by Audioscan.

Multiple USB devices may be used together by connecting them to the RM500SL USB port via a USB hub.

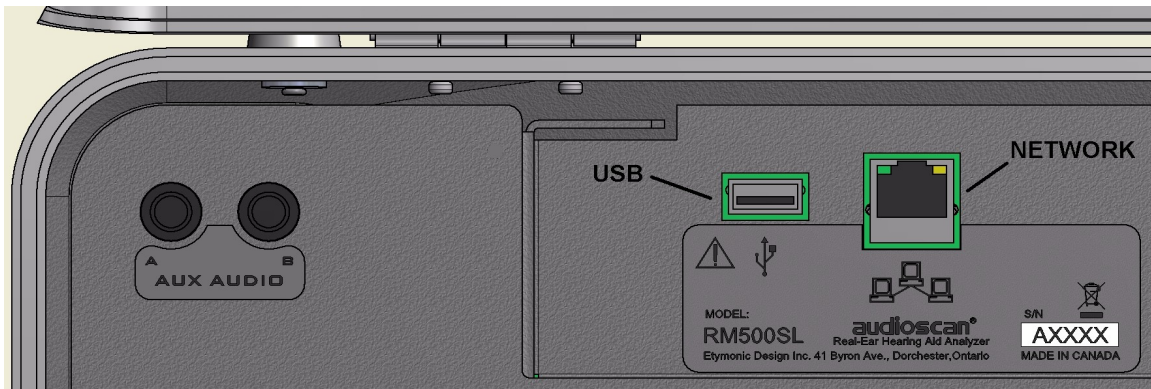

Auxiliary audio output jacks are not active in this version of software. Serial numbers below A2051 also have an RS232 serial port which is not active in this version of software.

An external printer may be connected to the the USB port. It may be color or black & white but it *must be PCL3, PCL5 or PostScript compatible*. The external printer must first be selected in Setup. See [Printing and Storing Results](#)

## 3 General Operation



This section describes the use of the built-in keypad, a QWERTY keyboard (not included) or a computer mouse (not included) to control the RM500SL and enter data. It also describes the use of an (optional) barcode scanner to enter data from printouts produced by Audioscan analyzers and provides instructions for updating the RM500SL operating software.

### Input device operation



Failure to follow operating instructions could place the user or operator at risk.

The RM500SL may be operated by means of the built-in keypad, an external mouse or an external QWERTY keyboard. These devices are used to summon on-screen menus and select items from them, to operate on-screen buttons and to input data. The scroll wheel on this type of mouse will scroll through long lists in list boxes and in Help. Clicking the right mouse button generates an image of the keypad which may be operated by the mouse. Clicking the left mouse button when the mouse pointer is on a graph will display a screen cursor with a digital readout of X and Y co-ordinates. Clicking again will dismiss the cursor. *Note that mouse speed can be changed by selecting Setup and Display.*

<i>Function</i>	<i>Keypad</i>	<i>QWERTY</i>	<i>Mouse</i>
Summon Help menu	<Help>	F1	Right click
Summon Setup menu	<Setup>	F2	Right click
Summon Test menu	<Tests>	F3	Right click
Summon Session menu	<Session>	F4	Right click
Switch between Ears or A/B Data or Help index and Help page	<Left/Right>	F5	Left click or Right click for keypad image
Print	<Print>	Print Scrn	Right click
Move across screen columns	 Arrows	 Arrows	Move mouse
Move within a screen column	Arrows	Arrows	Move mouse
Select a highlighted item or operate a screen button	Round key (<PICK> key)	Numeric Enter Key	Left click
Enter numeric data	Select point on chart	Numeric keypad	Left click on a point on chart
Enter text	Not possible	Any key	Not possible
Proceed from current state	<Continue>	Enter ↵	Click Continue
Revert to previous state	<Cancel>	Esc	Click Cancel

### Barcode data input



Failure to follow operating instructions could place the user or operator at risk.

In Speechmap and Insertion gain tests, audiometric data in barcode form on an Audioscan analyzer printout may

be entered by scanning the appropriate barcode. In Speechmap, air and bone threshold, UCL, RECD, audiometric transducer, age and ABR nHL to eHL conversion factors are encoded. In Insertion gain, threshold and transducer type are encoded. The type of data and the ear (left, right) is shown below the barcode. Only data for the displayed ear are imported. Barcodes may be scanned in any order and it does not matter if the barcode is 'upside down'.

1. Select Speechmap or Insertion Gain from the Tests menu.

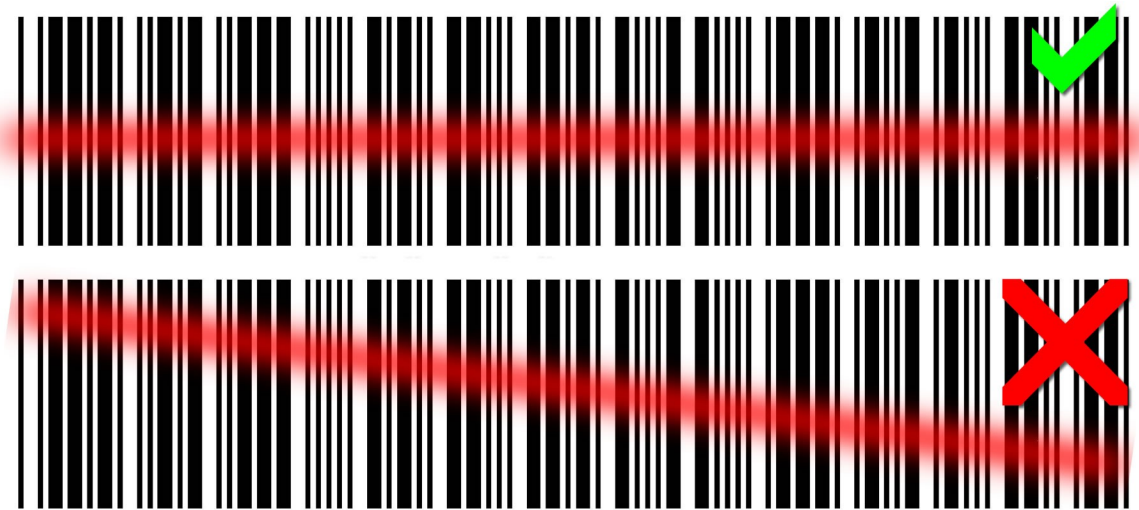

2. Hold the printout so that the barcode is flat. With the scanner 6 – 8 in. (15 – 20 cm) from the barcode, press the trigger on the scanner and center the illuminated red line along the length of the barcode.
3. When the scan is successful, the scanner will 'beep', the red line will extinguish and a Barcode Entry poster will appear on the screen. A green checkmark on the poster shows which data have been accepted. A message will advise if the barcode does not contain data for the screen you are viewing.
4. When all desired data have been accepted, select [Done] to apply the data.

See Barcodes, tabular data, headers and comments on printouts under [Printing and Storing Results](#).

## Keypad keys

<i>Keypad Button</i>	<i>Function</i>
<Help>	Summon context-sensitive Help Screen.
<Setup>	Summon Setup Menu containing a list of RM500SL features that can be modified. Any modifications made will be maintained after power off.
<Tests>	Summon Test Selection Menu containing a list of the available test procedures.
<Session>	Summon Session Data Menu to erase or export data
<Left/Right>	Used to alternate between ears or A/B Data.
<Print>	Print on internal or external printer or print to file.
 Arrows	Move across screen columns.
Arrows	Move within a screen column.
Round Key (<PICK> key)	Select a highlighted item or operate a screen button.
<Continue>	Proceed from current state.
<Cancel>	Revert to previous state.



## Menus, lists and buttons

*Menu buttons*

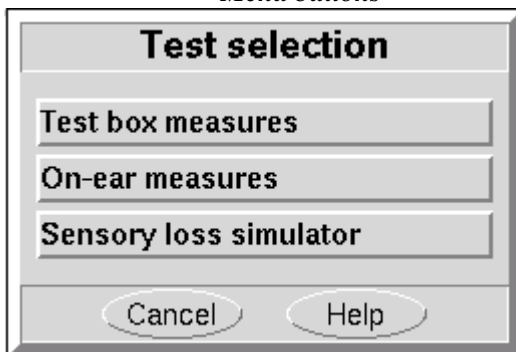

*Screen buttons*

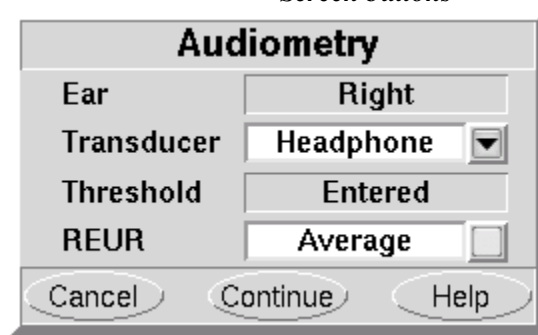

As illustrated above, menu buttons are gray rectangular bars containing descriptive text while screen buttons are

a highlighted square at the right-hand end of a white window. A screen button with a down arrow indicates that it will summon a drop-down list of options, the current selection being shown in the window to its left. A plain button toggles between two choices; the current choice is shown in the window to its left.

Positioning the mouse cursor over a menu button changes it from gray to white; positioning it over a window with a screen button changes the button from dark gray to light gray. Left clicking the mouse operates the selected button. A menu button or the window containing a screen button, selected using the keypad or a QWERTY keyboard is surrounded by a heavy line and is operated by pressing the <PICK> (round) key on the keypad or the Enter key on the *numeric keypad* on a QWERTY keyboard. This process also selects the highlighted item in a drop-down option list.

## Screen messages and Help

The Title bar (top line of the display screen) informs you of the selected Test (e.g., Speechmap).

The Message bar (bottom line of the display screen) suggests the next step in a test or informs you of the state of the instrument or conditions that could affect your data. For example, it will inform you if the microphones need to be calibrated.

Context-sensitive help is available by pressing <Help> or F1 on a connected QWERTY keyboard. The Left/Right key or a mouse may be used to switch between the Help index (left panel) and the Help page (right panel). The side sliders on each panel may be used to scroll through the Help index or long Help pages. This may also be accomplished using the  arrows, the scroll wheel on the mouse or the arrows on a QWERTY keyboard.

## Software updating

The software currently running on your RM500SL is stored in the system USB flash drive found in the test chamber. Future updates will be installed to this drive via your PC. You may download the latest software from [www.audioscan.com](http://www.audioscan.com) or request that a CD-ROM be mailed to you. Instructions for transferring the software update from your PC to the RM500SL will be included with the software download or the CD-ROM.

## 4 General Setup

This section covers Date and Time setup, Display settings (including mouse pointer speed setting) and Saving test setup.

### Date and time setup

To set the date and time that appears on printouts and calibration screens:

1. Press <Setup>, then highlight and <PICK> [Date & Time] on the Setup poster.
2. To change the date, highlight and <PICK> the month window to display a drop-down list of months.
3. Highlight and <PICK> the desired month on the list.
4. Repeat the previous step to change the date, year and time in the appropriate windows.
5. When the new date and time information has been set, press <Continue> to exit.

### Display settings

To change the screen language, screen saver timing and the background color for charts:

1. Press <Setup>, then highlight and <PICK> [Display].
2. To change the screen language, highlight and <PICK> [Language] to toggle between English and German.
3. To change the idle time before the screen saver blanks the screen to prolong display life, highlight and <PICK> the Screen saver window.
4. Highlight and <PICK> the desired screen saver timing from the drop-down list.
5. To change the background color of the graphic display on the various test screens, highlight and <PICK> [Color] to toggle between black and white.
6. In this screen you can also select the Mouse pointer speed button and select the response speed from the drop-down list.
7. Press <Continue> to exit setup.

### Saving test setup

This feature lets you retain the last-used stimulus type and level for most tests when the power is turned off and the last-used target method and transducer type in Speechmap and Insertion Gain tests. This feature also lets you determine how assessment parameters, test levels and stimuli are treated when <Session>, [Erase data] is selected.

To enable/disable saving of test levels, stimuli and assessment parameters:

1. Press <Setup>, then highlight and <PICK> [Save option]

2. Highlight and <PICK> [Save test setups on power off] to toggle between Yes and No.

To enable/disable erasing of test levels, stimuli and assessment parameters when Erase data is selected:

1. Press <Setup>, then highlight and <PICK> [Save option]
2. Highlight and <PICK> [Save test setups on erase data to toggle between Yes and No.



## 5 Networking



Failure to follow operating instructions could place the user or operator at risk.

Connection to a computer network allows screen images to be printed on a network printer or on a shared printer on a networked PC. Images and underlying data may also be saved to a shared folder on a networked PC. See [Printing and Storing Results](#) for details. The RM500SL may also be connected to a single computer using a network router, switch or hub. Note that sharing data with NOAH is done over this network connection.

### Networking requirements

Connection of the RM500SL to a computer network requires a Cat 5, RJ-45 cable.

The RM500SL can connect to a local area network (LAN) using either automatic or static internet address assignment. Most home and small-office networks use automatic addressing. These networks have a DHCP server (Dynamic Host Configuration Protocol). Special-purpose networks might use static address assignment provided by the network administrator.

### Networking setup

Check [Networking requirements](#) and connect the RM500SL to your network.

1. Press <Setup> and then choose [Network] from the Setup menu.
2. In the Network poster, select [Enable].
3. In most cases, your network will support automatic address assignment (DHCP) and you need only select [Auto] and click on [Test ].
4. If the test is successful, your computer domain, address and port assignments will be reported.

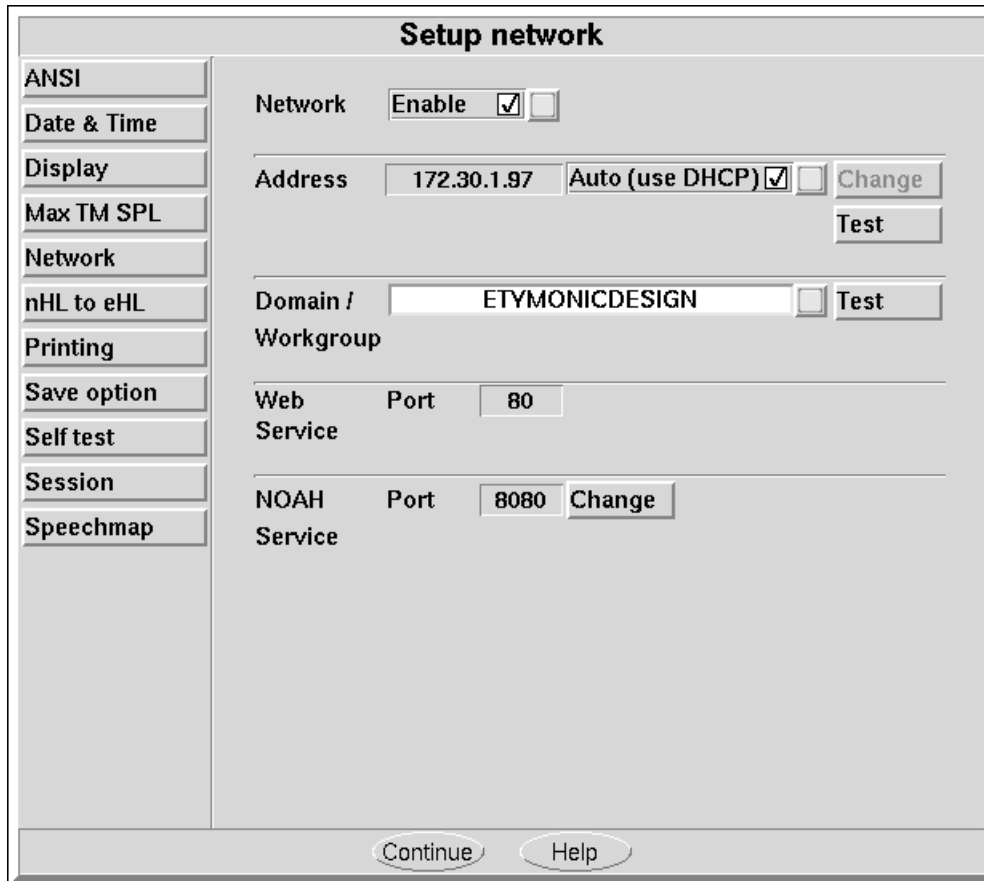

Note for network administrators: To manually change networking settings, uncheck Auto and click the Change button.

## NOAH Service Port

Consult your Network Administrator before changing the NOAH service port. Changing the port successfully requires understanding the security policies on your Windows PC and computer network.

The Audioscan NOAH Module communicates with the RM500SL through the NOAH network service. The RM500SL provides the NOAH service on a TCP port. The Windows computer running the module must be configured to access the same TCP port, which is 8080 by default. Some Windows anti-virus software packages and some network firewalls prevent access to specific ports, including 8080. Using the NOAH module in the presence of such security settings may necessitate changing the NOAH service port.

Note that changing the NOAH service port requires restarting the Product software.

## Changing the NOAH service port

1. Press <Change> next to the NOAH service port.
2. Select the appropriate five digits to enter the desired port number. The software will prevent you from entering the same port as the Product web service (typically port 80).

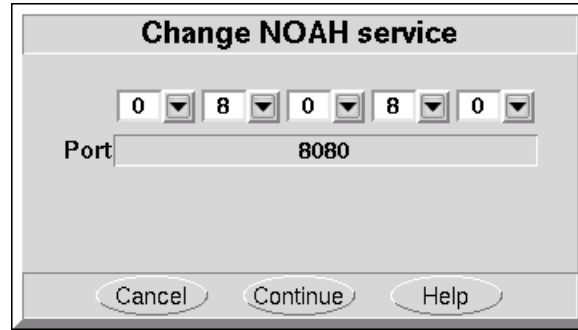

3. Select <Continue>.
4. You will be prompted to restart the equipment. Select <Continue> to restart, or <Cancel> to enter a different port number.



## Testing the NOAH service port

The RM500SL provides the NOAH service using the HTTP protocol. Communication between the Windows PC and the RM500SL can be tested using an ordinary web browser.

1. On the Windows PC, enter the RM500SL network address and port number into a web browser following this example:

`http://172.30.86:8080/noah`

2. If the communication is successful, the web browser will display NOAH data formatted in XML:

`<noah> Example XML </noah>`

## 6 Single computer connection

Most office computers today are already connected to a network, through either a wired or wireless (wifi) interface. In these cases, the RM500SL must be added to the same network as the computer. (See Networking for details.) In cases where no network exists, the RM500SL can be networked directly to a single computer. There are two methods, depending on the network hardware available. The following two sections describe the alternatives. The computer must be running Windows 7 or higher and have an available, functioning network port.

*Please note: only use these methods of connection if your PC is not currently on any network (i.e. the computer does not print to a network printer, does not receive email, and does not have Internet access). Adding a second network connection to a Windows PC is complex and can have unexpected effects on the primary connection.*

### Automatic connection (recommended)

Automatic connection requires a small 10/100 network router. Most routers have DHCP address assignment active by default and do not require changes from the default Windows settings on the computer to establish a simple connection with a RM500SL.

3. Connect a Cat 5, RJ-45 cable from one router port to the RM500SL network connector.
4. Connect a second cable from a router port to the network connector on the PC.
5. On the RM500SL, press <Setup> and then choose [Network] from the Setup menu.
6. Select [Enable]. Ensure the Auto checkbox is checked, and choose [Test].

A network address will be provided by the router and should show up in the 'Network address' window.

*By default, Windows 7 computers have networking and DHCP enabled so at this point your connection should be complete.*

If required, to check your PC settings:

1. Go to Control Panel / Network and Sharing Center then select 'Change Adapter Settings' on the left-hand panel.
2. Right-click on Local Area Connection and choose Properties. Ensure that Internet Protocol (TCP/IP or TCP/IPv4) is checked. Select this and select the Properties button. Ensure that 'Obtain an IP address automatically' is selected.

### Static connection

A static connection requires an Ethernet switch. The Network addresses must be entered manually into the RM500SL and into the computer's Windows network setup.

1. Connect a Cat 5, RJ-45 cable from one port on the Ethernet switch to the RM500SL network connector.
2. Connect a second cable from another port on the Ethernet switch to the computer's network connector.
3. In Windows 7, go to Control Panel / Network and Sharing Center then select 'Change Adapter Settings' on the left-hand panel.
4. Right-click on Local Area Connection and choose Properties. Ensure that Internet Protocol (TCP/IP or TCP/IPv4) is checked. Select this and select the Properties button.
5. Check 'Use the following IP address' and enter the following in the IP address box: 172.30.1.1. Enter

255.255.255.0 in the Subnet mask box.

6. On the RM500SL, un-check Auto (use DHCP) on the Setup network screen and click the Change button. Then set the network addresses as shown below by clicking on the down arrow buttons and selecting from the drop-down lists.
7. On the RM500SL, uncheck Auto on the Setup network screen and click the Change button. Then set as shown below by clicking on the down arrow buttons and selecting from the drop-down lists.

Change network address				
IP Address	172	30	1	2
Network	172	30	1	0
Broadcast	172	30	1	2
Netmask	255	255	255	0

Cancel  Continue  Help

8. Select [Continue].
9. Click on the Test button to check that a connection has been established.

## 7 Printing and Storing Results

Pressing <Print> will cause the current screen image to be printed on the internal printer, on an external local printer, on a network printer, on a Windows-shared printer on a networked PC, or saved to file on a USB memory stick, or a Windows-shared file on a networked PC. Date, time, barcoded audiometric data and fixed or variable headers and comments (via a connected keyboard), may be added to printouts (but not when saving to a file). Tabular data may be appended to printouts of graphic data. Session data may also be saved as an xml file to a USB memory stick or in a Windows-shared folder on a networked PC for further analysis or to be restored to a RM500SL or another Audioscan analyzer.

**NOTE:** If a header, comment, or client ID field, or file name, identifies the printed or saved data as belonging to an individual, it becomes Individually Identifiable Health Information and must be protected under the HIPAA Security Rule. See Appendix 1: Manufacturer Disclosure Statement for Medical Device Security.

### Internal printer paper loading

On-screen instructions on paper replacement are provided when the paper lever has been raised.

To load a new roll of paper:

1. Press the <Print> key for on-screen instructions.
2. Remove the empty spool from the paper tray and any remaining paper from the printer.
3. Hold a new roll in front of the paper tray with paper feeding from the top of roll.
4. Insert the paper's leading edge into the lower slot at rear of tray.
5. Feed the paper by highlighting the on-screen [Paper Feed] button and pressing <PICK>.



6. Advance the paper until it comes out of the upper slot.

7. Place the roll in the paper tray and advance another 10 in. (25 cm) of paper.
8. Lower the printer head using the small black lever. Press <Continue>.

**If nothing shows on the paper when you press <Print> and the paper is coming out –check that the glossy side is up as it comes out of the printer.**

**Unused thermal paper may darken if stored for prolonged periods at elevated temperatures and lose contrast if subjected to light. Keep long-term supplies in a cool dry place out of direct light.**

## Barcodes, tabular data, headers and comments on printouts

The date and a header, such as a facility name, may be added to printouts. Barcodes representing hearing threshold, UCL and RECD, where applicable, may be added to printouts of Speechmap, Insertion gain and RECD tests. Tabular data, where applicable, may be appended to printouts. Lines for hand-written notes or typed comments may also be added.

1. Connect a computer keyboard to the USB port on the connector panel.
2. Press <Setup>, then highlight and <PICK> [Printing].
3. Highlight [Page setup] and press <PICK> to display the page setup poster.
4. To print the *date and time* on each printout, highlight and <PICK> [Date].
5. To print *lines* for handwritten notes, highlight and <PICK> [Lines].
6. To add *barcodes* for audiometric data, highlight and <PICK> [Barcode].
7. To add *tabular data*, highlight and <PICK> [Graph with table].
8. To print a *fixed header* on printouts, highlight and <PICK> [Header]. Enter the desired header (up to 35 characters) on the connected keyboard. Press <PICK> (or Enter on the keyboard number pad) to complete the entry. To be prompted for a *new header* for each printout, highlight and <PICK> [Ask].
9. To print *fixed comments* following a printout, highlight and <PICK> [Description]. Enter comments on the connected keyboard. Press <PICK> (or Enter on the keyboard number pad) to complete the entry. To be prompted for *new comments* for each printout, highlight and <PICK> [Ask].
10. To be prompted for a *new file name* each time you print to a USB memory stick or a network file, highlight and <PICK> [Ask]. *Do not use space \$ \ / or tab in the file name.* USB file names are limited to 8 characters. See [Printing to a USB memory stick](#) or [Printing to a network file](#).
11. A print layout for the selected printer is displayed.
12. Press <Continue> to exit page setup and <Continue> to exit Setup.

## Local printer setup



Failure to follow operating instructions could place the user or operator at risk.

1. Connect an external printer to the USB port on the connector panel. *Only PCL 3 (not PCL3GUI), PCL 5, ! PostScript compatible printers are supported, as well as, HP Laserjet Pro 1660, and Deskjet models 3050, 1000, D2680, D4160, 6940 and 460.*
2. Press <Setup>, then highlight and <PICK> [Printing].
3. Highlight & <PICK> [USB].
4. Highlight & <PICK> [Printer details] (automatic if printer type is set to None).
5. Highlight & <PICK> [Printer type].
6. Highlight & <PICK> your printer type. Select HP Deskjet Color(1) for a printer with a single ink cartridge;



HP Deskjet Color(2) for a printer with separate color and black ink cartridges; HP Laserjet Black. Check [Black only] for black printouts on a color printer. Select Other HP for a list of supported specific printer models and Press <Continue>.

7. If Other HP was selected, pressing <Continue> summons the HP printer selection menu. Select a Printer model from the drop-down list and press <Continue>.
8. Press <Continue> to exit Setup.

## Printing to USB memory

1. Plug a USB memory stick into the USB port on the recessed connector panel. The RM500SL may be either on or off.
2. Press <Setup>, then highlight and <PICK> [Printing].
3. Highlight and <PICK> [Print to USB file].
4. Highlight and <PICK> [Printer details] to change the file type [Bitmap (bmp)] or [Internet GIF (gif)] and the captured area [Full screen], [Main window] (full screen without the message line or [Active window] (foreground image only).
5. Press <Continue> to save the settings and exit the setup menu.
6. To save a screen image to a file, press <Print>. After about 4 seconds, a message will advise that the USB stick is being accessed. *Do not unplug the USB stick until this message disappears.*

NOTE: To input a file name from a connected keyboard each time you print, see Barcodes, tabular data, headers and comments on printouts.

NOTE: To save all test data as an xml file, see Storing and restoring data.



## Network printer setup

To print to a network printer or to a Windows-shared printer on the network, you must first enable networking. See section [Networking](#). To print to a printer on a Windows PC connected to a network, you must also share the printer on the PC by selecting Start, Settings and Printers. Then right click on the printer you wish to share and select Sharing. *Only PCL 3 (not PCL3GUI), PCL 5, !PostScript compatible printers are supported, as well as, HP Laserjet Pro 1660, and Deskjet models 3050, 1000, D2680, D4160, 6940 and 460.* In Windows2003 Server you must add permission to allow Anonymous Logon to print to the shared printer.

1. Press <Setup>, then highlight and <PICK> [Printing].
2. Highlight & <PICK> [Other network printer] or [Windows shared printer].
3. Highlight & <PICK> [Printer details] (automatic if printer type is set to None).
4. Highlight & <PICK> [Printer type], then select from HP Deskjet Color(1) (single ink cartridge), HP Deskjet Color(2) (both color and black ink cartridges), HP Laserjet Black, PostScript or Other HP (for a list of supported specific printer models). Check [Black only] for black printouts on a color printer.
5. Connect a USB computer keyboard to the RM500SL and fill in the boxes with the requested information. Highlight and <PICK> each box to open it for data entry and again to close it (or use the Enter key on the keyboard's number pad). Obtain needed information from your network administrator.

6. Press <Continue> to save the settings and exit the setup menu.

## Printing to a network file

To save the screen image as a file on a network PC, you must first enable networking. See [Networking](#). You must also "share" a folder on the PC (e.g. c:\MyData) and ensure that Change permissions are enabled.

1. Press <Setup>, then highlight and <PICK> [Printing].
2. Highlight and <PICK> [Print to file].
3. Highlight and <PICK> the file type [Bitmap (bmp)] or [Internet GIF (gif)].
4. Highlight and <PICK> [Full screen], [Main window] (full screen without the message line or [Active window] (foreground image only).
5. Connect a USB computer keyboard to the RM500SL and fill in [Computer], [Share name], [Username] and [Password] (not needed for Windows 95/98). Highlight and <PICK> each box to open it for data entry and again to close it (or use the Enter key on the keyboard's number pad).

6. Highlight and <PICK> [Test connection] and wait for a successful report.
7. Press <Continue> to save the settings and exit the setup menu.
8. To save a screen image to a file, press <Print>.

The screenshot shows a window titled "Network file" with the following fields and values:

File type	Bitmap (bmp)	▼
Print frame	Main window	▼
Computer	My PC	□
Share name	My Data	□
Username	Me	□
Password	*****	□

At the bottom of the window is a button labeled "Test connection".

NOTE: To input a file name from a connected keyboard each time you print, see [Barcodes, tabular data, headers and comments on printouts](#). To save all test data as an xml file, see [Storing and restoring data](#).

## Storing and restoring data – setup

All measurement data (curves) displayed at the end of the test are stored until overwritten by repetition of the same test, invalidated by a related test (in such cases, the message bar will inform you of impending data loss), erased by selecting <Session> and one of the [Erase data] choices or the power is turned off. (Setup data will be retained even after the power is turned off.)

The RM500SL database may be stored and restored via xml files on a USB drive or a networked PC share. If the data exchange location is a network share, you must first enable networking. See [Networking](#). You must also "share" a folder on the PC (e.g. c:\MyData) and ensure that Change permissions are enabled.

### To enable and configure file-based data exchange:

1. Press <Setup>, then highlight and <PICK> [Session].
2. Highlight and <PICK> [Enable file based data exchange].
3. Highlight and <PICK> the storage file location [USB drive or Network share].
4. For Network share connect a USB computer keyboard to the RM500SL and fill in [Computer], [Share name], [Username] and [Password] (not needed for Windows 95/98). Highlight and <PICK> each box to open it for data entry and again to close it (or use the Enter key on the keyboard's number pad). Highlight and <PICK> [Test connection] and wait for a successful report.
5. Press <Continue> to save the settings and exit the setup menu.

## Storing and restoring data

The RM500SL database contains all the test and setup data for the RM500SL at any point in time. The Session store features saves this database in xml format which may be viewed with a web browser or imported into an Excel spreadsheet or returned to the RM500SL to recreate the session. The data is saved in a file which you can name using a connected computer keyboard. This name (the Client ID) may not contain ! ~ ` @ # \$ % ^ & \* + = \ / ? < , .>. A number is automatically appended to the name you enter and this number is incremented each time you add a session to this Client ID (e.g. Andy.1.xml, Andy.2.xml, Andy.3.xml). If you do not enter a name, the file will be named session.#.xml (e.g. session.1.xml, session.2.xml, session.3.xml).

**NOTE that Client IDs starting with numbers appear at the top of the list, followed by those that start with upper case letters while those starting with lower case letters will be at the bottom of the list. It is recommended that you use a consistent system when creating Client IDs (such as all upper case letters) to avoid duplicate entries.**

If the Client ID links the data to an individual, the printout becomes ePHI (electronic Protected Health Information) which must be protected under the HIPAA Security Rule.

### To store session data to a file:

1. Press the <Session> key, then highlight and <PICK> the top list button on the Session data poster.
2. Highlight and <PICK> [Store session to file] from the list.
3. Highlight and <PICK> the Client ID list button. This will display a list of Client IDs with the first entry highlighted.
4. To add a session to an existing file
  1. Use the mouse or the arrow keys on the keypad or connected keyboard to move the highlight in the list, **OR** start typing the file name on a connected keyboard. The highlight will move to the closest match as you type.
  2. When the desired file name is highlighted, press <PICK> or left click on the Client ID button (you can always left click on any file in the list to select it without highlighting it). This will put the file name in the Client ID window and close the list.
  3. Pick <Continue> to store the current session data to the file in the Client ID window with a new session number appended.
5. To add a new file to the Client ID list
  1. Display the Client ID list and start typing the new file name. As you type, the first matching entry in the list will be highlighted and this highlight will move as you type (the highlight will disappear when the file name you have typed does not duplicate an existing name).
  2. When you finish typing the Client ID, click on the Client ID button or press <PICK>. This will close the drop-down list and leave the new file name in the Client ID window.
  3. Pick <Continue> to store the current session data to the file in the Client ID window.

NOTE: A style sheet (audioscan.xsl) is automatically saved with the data file. To open the saved data file in Excel, right click on the file and select Open With.> Microsoft Excel. When prompted for a style sheet, select audioscan.xsl from the choices presented (keep the style sheet in the same folder as the data file).

**To restore a session from a file:**

1. Press the <Session> key, then highlight and <PICK> the top list button on the Session data poster.
2. Highlight and <PICK> [Restore session from file].
3. Highlight and <PICK> the Client ID list button. This will display a list of Client IDs with the first entry highlighted.
4. Use the mouse or the arrow keys on the keypad or connected keyboard to move the highlight in the list, OR start typing the file name on a connected keyboard. The highlight will move to the closest match as you type.
5. When the desired file name is highlighted, press <PICK> or left click on the Client ID button (you can always left click on any file in the list without highlighting it). This will put the file name in the Client ID window and close the list.
6. Highlight and <PICK> the Session list button to generate a list of previously stored sessions for the indicated Client ID.
7. Highlight and <PICK> a session and press <Continue>.

## **Data storage using NOAH**

Audioscan offers a module for storing data in the NOAH framework on a Windows PC. Contact Audioscan or visit [www.audioscan.com](http://www.audioscan.com) for details.

## 8 Test Box Measures - Setup

The appearance of Test box measures screens may be changed in several ways. Most screens may be formatted to show results in graphical or tabular format. The Multicurve screen may be scaled in dB SPL or dB Gain. Individual curves may be hidden (but not erased).

### Test box screen

For most tests, two completely separate sets of test results, labeled A and B, may be retained and displayed. To switch between A and B test results, press the <Left/Right> key.

### Format

Except for Distortion, Input/Output, Battery drain and Manual control screens, you have the option of selecting either a graphic or tabular format.

To change the *data format*, highlight, then <PICK> [Graph] or [Table].

### Scale

On the Multicurve test screen, you have the option of displaying test results in SPL (dB) or gain (dB).

To change the *scale*, highlight, then <PICK> [dB SPL] or [dB Gain]

### Hide or Show test box curves

To hide or show test curve(s):

1. Highlight, then <PICK> Curve [Hide/Show].

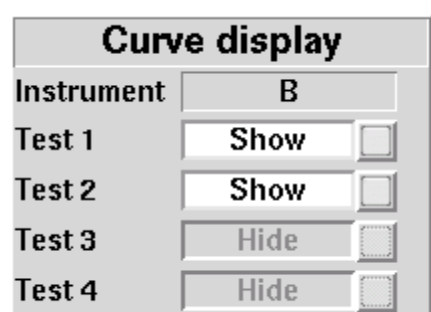
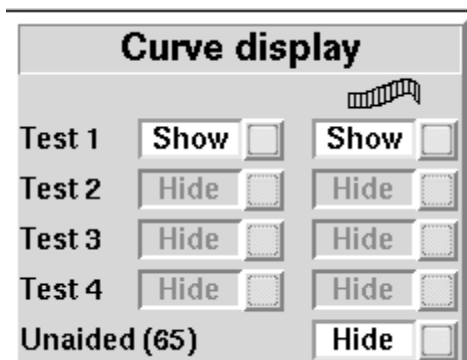

2. Highlight, then <PICK> the desired test to toggle between the Hide or Show options. The curve will toggle on or off when selected. The envelope of speech curves in Speechmap may be displayed or hidden for clarity of display by toggling the buttons under the  column. Note that you may set the envelope to automatically hide whenever a new test is run 1.(see Speechmap – Speechmap Setup).

3. Press <Continue> to return to the test screen.

Hiding a curve does not erase it. To erase curves use the <Session> key.

## 2003 or 2009 ANSI standard

Automated tests of linear and AGC hearing aids may be conducted according to either the ANSI S-3.22-2003 or ANSI S3.22-2009 test standards. For differences, see ANSI S3.22-200x facts

To select the standard to be used:

1. Press <Setup>, then highlight and <PICK> [ANSI]
2. Highlight and <PICK> the version of the ANSI standard you wish to use.
3. Press <Continue> to exit

## ANSI test frequencies

The Frequencies feature allows hearing instruments to be evaluated at the Special Purpose Average (SPA) frequencies defined by ANSI S3.22, rather than the default High Frequency Average (HFA) frequencies. The choice of SPA (or HFA) frequencies influences the average OSPL90, average full-on gain, reference test gain, bandwidth and equivalent input noise. The frequencies at which distortion is measured are one-half the selected SPA frequencies. You can also select the frequencies at which attack and release times are measured.

### To change the averaging frequencies:

1. Press <Setup>, then highlight and <PICK> [ANSI].
2. Highlight and <PICK> the HFA/SPA button to generate a drop-down list box of alternate test frequencies.
3. Highlight the desired HFA/SPA test frequencies and press <PICK> to select.

### To change the frequencies for attack and release time measurements:

In the list of available frequencies, highlight and <PICK> the frequencies to be used to measure attack and release time.

Press <Continue> to exit.

## Test box calibration facts

Test box microphone calibration establishes a correction curve for the uncalibrated test box reference microphone by comparison with the factory calibrated coupler microphone. It may be performed as often as desired but will be invalidated at 12 am the following day or at 12 am the following week, depending on the choice of Daily or Weekly calibration interval. After the calibration has expired, the message window will turn blue and you will be prompted to calibrate whenever you attempt a test that uses the test box microphones.

Your calibration curve should be similar to the one shown but may be at a different level. It should remain stable over time. Irregularities in the calibration curve may be the result of not properly aligning the microphones. See [Calibrating test box reference microphone](#).

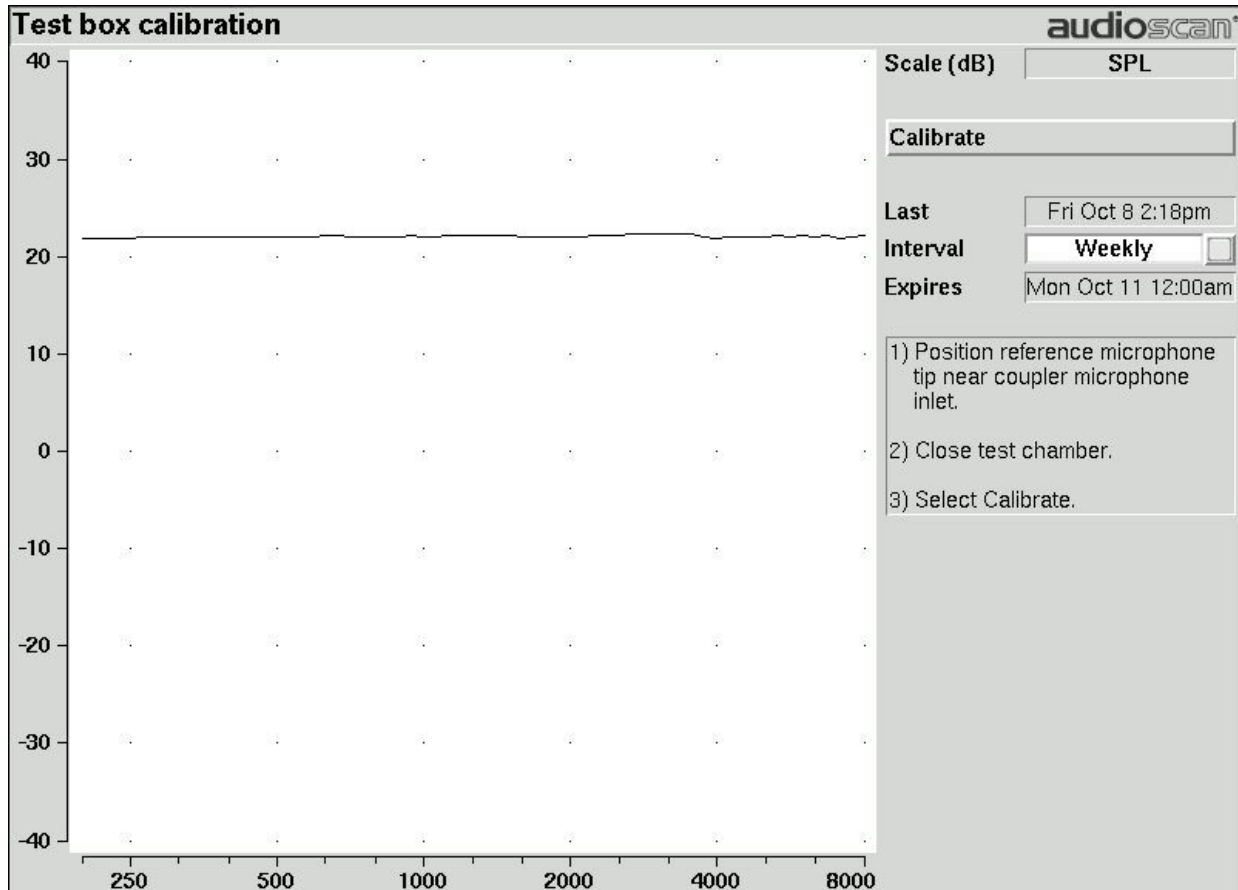

## Calibrating test box reference microphone

*Remove any coupler from the coupler microphone before calibration.*

1. Position the test box reference microphone opening concentric with the coupler microphone opening and about 1 – 2 mm from as shown below.
2. Close and seal the test chamber.
3. Press <Tests>, then highlight and <PICK> [Test box measures], then highlight and <PICK> [Calibration].
4. Highlight, then <PICK> [Daily] or [Weekly] to select the calibration interval.
5. Highlight and <PICK> [Calibrate]. See [Test box calibration facts](#).
6. To change the Weekly calibration day, press <Setup>, then highlight & <PICK> [Date & Time].

It is recommended that you print a copy of the initial calibration curve and compare it with your daily or weekly curve. Any change in this curve indicates a drift in either the coupler or the reference microphone which needs further investigation. See [Calibration check for coupler microphone](#) for an additional check.

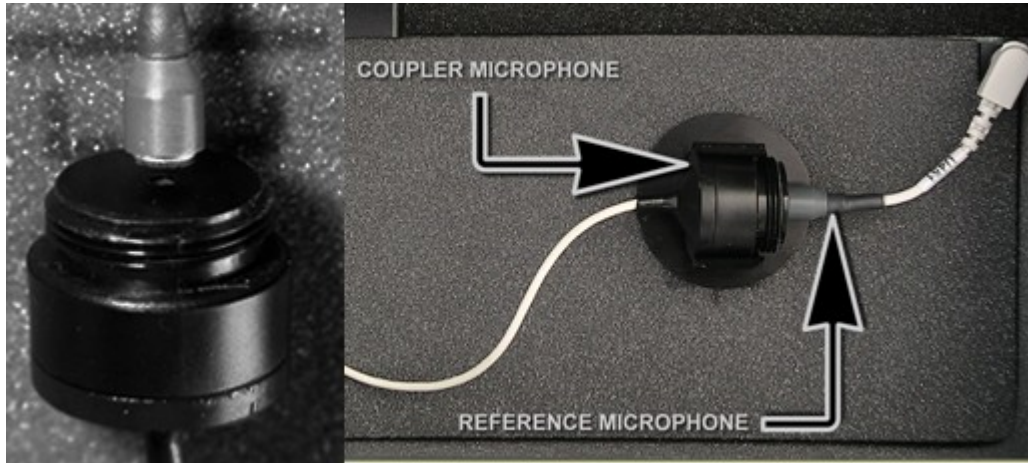

## Calibration check for coupler microphone

Accuracy of test box measurements depends on the calibration of the coupler microphone. This should be checked regularly using a microphone calibrator with an adapter ring. The RE780 (1 1/8 in.) and RE781 (1in.) rings are designed for Quest CA22 and QC-10/20 respectively. To verify the coupler microphone calibration:

1. Calibrate the test box reference microphone. See [Calibrating test box reference microphone](#)
2. Screw the appropriate calibrator ring onto the coupler microphone.
3. Insert the coupler microphone with the attached calibrator ring into the calibrator opening.
4. Turn the calibrator on and adjust it to present one of the available frequencies and levels (e.g., 94 dB SPL at 1000 Hz).
5. Press <Tests>, then highlight and <PICK> [Test box measures], then highlight and <PICK> [Manual control].
6. Highlight and <PICK> the [Level] window, then highlight and <PICK> 0 from the drop-down list.
7. Highlight, then <PICK> the [Frequency] window, then highlight and <PICK> the frequency of the calibrator (e.g. 1000 Hz) from the drop-down list.
8. Highlight, then <PICK> the [Filter] window, then highlight and <PICK> 1/12th octave from the drop-down list.
9. Highlight, then <PICK> [Start test] (which changes to [Stop test]).
10. Check that the Coupler microphone level is within 1 dB of the calibrator level setting, +/- the calibrator accuracy. For a 94 dB calibrator with +/- 0.3 dB accuracy, the indicated coupler microphone level should be 94 +/- 1.3 dB.
11. To stop the measurement, highlight and <PICK> [Stop test].



## Coupling the hearing instrument for ANSI/IEC tests



**WARNING:** To reduce the risk of contamination, hearing instruments should be clean before putty is applied and putty should be replaced frequently

The RM500SL is supplied with 2 metal couplers, a type HA-1 (ITE) and a type HA-2 (BTE). *Note that an ANSI standard coupler for CICs does not exist. These must be tested in the HA-1 coupler.*

When threading the couplers onto the coupler microphone, *it is very important that they be firmly tightened* to ensure a good acoustic seal. Avoid twisting the coupler microphone cable – turn the coupler not the microphone or unplug the microphone while tightening the coupler.

**BTE** instruments are coupled to the HA-2 coupler by means of a 9 mm length of black Viton tubing. The only purpose of this tubing is to seal the tip of the earhook to the coupler inlet. All of the tubing required by ANSI S3.22 is machined into the metal stem of the HA-2 coupler. The HA-2 coupler tubing should be inspected regularly for cracks which will cause feedback. If the tubing is worn or damaged, contact Audioscan for a replacement. Alternatively, it can be replaced by a 10 mm length of #13 heavy wall earmold tubing.

**Custom** instruments are sealed to the HA-1 coupler with putty so that the end of the eartip is flush with the inside of the coupler opening. Putty should not extend into the coupler cavity or block the sound outlet of the instrument. *Vents should be sealed at the faceplate end.* It is very important that the instrument be well-sealed to the coupler.

**Open fit** instruments must use the coupler and coupling system specified by the manufacturer. This may involve a hook that replaces the open fit tubing or an adapter tube that may be sealed to the opening of the HA-1 coupler with putty.

**RITE (Receiver in the ear)** instruments are coupled to the HA-1 coupler using putty to seal the receiver module or soft tip to the coupler opening.

*Excess low frequency output is usually due to open vents or a poor seal to the coupler.*

*For health reasons, hearing instruments should be clean before putty is applied and putty should be replaced frequently.*

## Coupling the hearing instrument for Test box Speechmap



**WARNING:** To reduce the risk of contamination, hearing instruments should be clean before putty is applied and putty should be replaced frequently

*The ANSI S3.46-2013 standard specifies RECD referenced to the HA-1 coupler and suggests its use in test box verification for all instrument types. Audioscan software allows for BTE coupling to either HA-1 through earmold, or HA-2 with a software correction.*

**BTE** instruments may be coupled either directly to the HA-2 (BTE) coupler, or to the HA-1 coupler using the client's earmold and blue putty. When using the earmold, ensure that the mold is well-sealed to the coupler and that the medial end is flush with the inside of the coupler opening. Putty should not extend into the coupler cavity or block the sound outlet. *Vents should be sealed at the lateral end.* Coupling method used for BTE instruments (HA-2 or HA-1) must be specified in Instrument type selection on Speechmap screen. See [Using Speechmap, RECD](#)

**Custom** instruments are sealed to the HA-1 coupler with putty so that the end of the eartip is flush with the

inside of the coupler opening. Putty should not extend into the coupler cavity or block the sound outlet of the instrument. *Vents should be sealed at the faceplate end.* It is very important that the instrument be well-sealed to the coupler.

**Open fit** instruments may not be verified using Test box speechmap.

**RITE (Receiver in the ear)** instruments are coupled to the HA-1 coupler using putty to seal the receiver module or soft tip to the coupler opening.

*Excess low frequency output is usually due to open vents or a poor seal to the coupler.*

*For health reasons, hearing instruments and earmolds should be clean before putty is applied and putty should be replaced frequently.*

## Positioning the hearing instrument

1. The hearing instrument should be coupled to the appropriate coupler and a battery or battery pill installed. See Coupling the hearing instrument and Battery pill use and care.
2. Place the instrument and coupler in the test chamber so that the microphone opening(s) of the instrument are on the crossbar within the test zone.

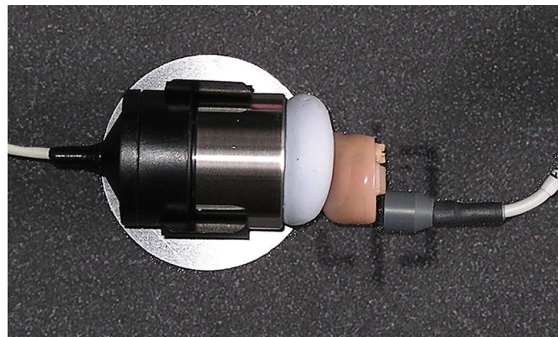

3. Position the test box reference microphone as close as possible to the (front-facing) microphone opening of the hearing instrument without touching it.
4. Close and seal the test chamber.

## 9 ANSI/IEC Hearing Aid Tests

These tests follow the procedures of ANSI S3.22-2003 or ANSI S3.22-2009 as selected in Setup:

**ANSI:** An automated test sequence for hearing instruments per ANSI S3.22-2003

**ANSI / IEC:** An automated test sequence for hearing instruments per ANSI S3.22-2009 and IEC 60118-7

**Input/Output:** 1 - 4 curves of coupler SPL vs input SPL at .25, .5, 1, 2 and 4 kHz.

**Telecoil:** Tests for telephone sensitivity and test loop sensitivity using a telephone magnetic field simulator (TMFS) and a large coil in the test chamber floor.

### ANSI S3.22-200x facts

ANSI S3.22-2003 and ANSI S3.22-2009 have been designated a recognized standard by the FDA and are mandatory for reporting test data.

ANSI S3.22-2009 and IEC 60118-7 have been harmonized. There is no difference between these standards.

The only difference between ANSI S3.22-2003 and ANSI S3.22-2009 is that ANSI S3.22-2003 includes attack and release tests.

Full-on gain is determined with 50 dB input SPL and frequency response curves are run at 60 dB SPL for all aids.

The OSPL90 curve, the HFA (or SPA) and peak value of this curve, the frequency of the peak, the HFA (or SPA) full-on gain are determined at full-on gain setting. The response curve, frequency range, Reference Test Gain, battery drain, equivalent input noise, distortion, attack and release times are determined at RTS.

### ANSI 2003 and 2009 /IECtests

#### ANSI test results

Full-on average gain (1) is measured with a 50 dB input SPL, average gain at RTS (2) is always measured at 60 dB input SPL and the frequency response curve (3) is always run at 60 dB input SPL.

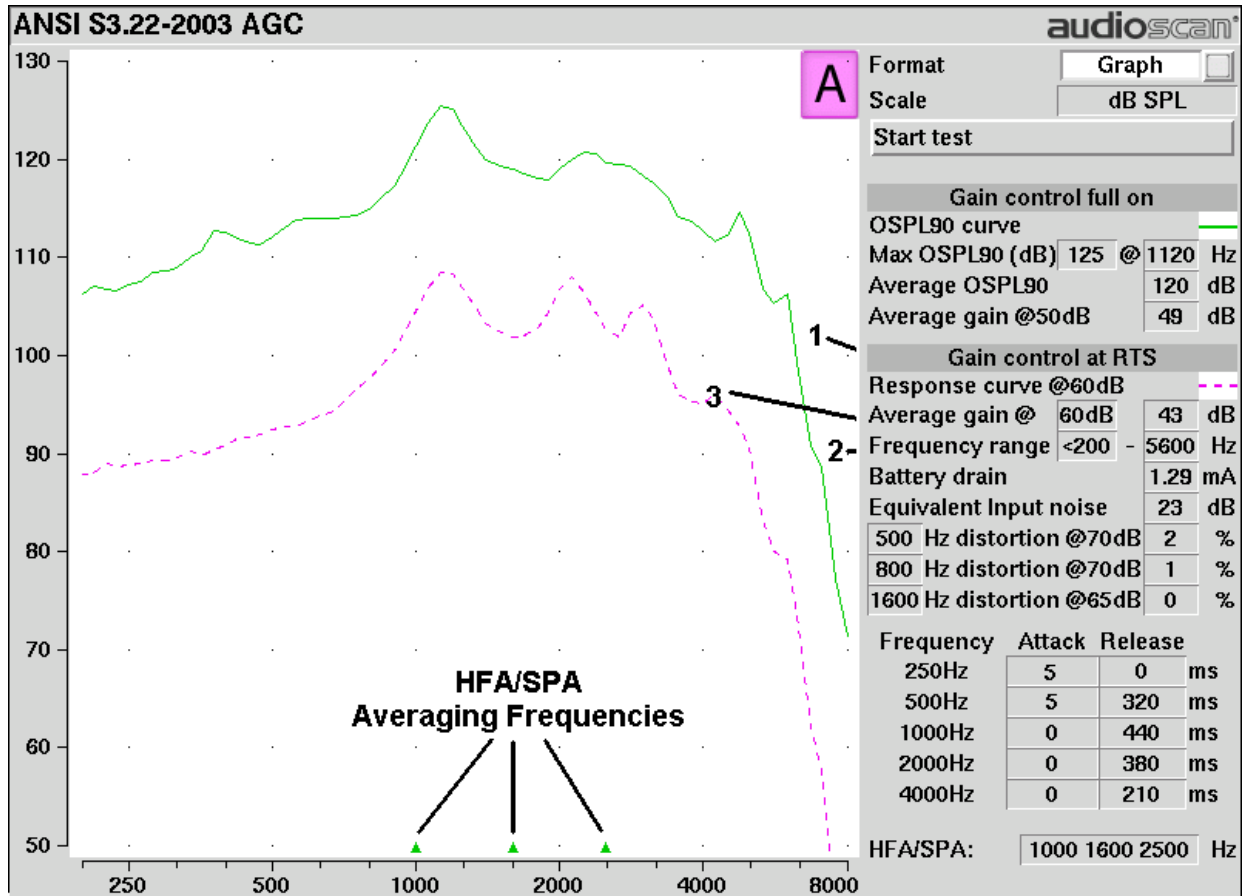

## ANSI input-output curves

An input/output curve shows the output level of a hearing instrument as a function of input level and frequency. It is a steady-state pure-tone curve and does not reflect performance with complex signals such as speech.

You may run the tests at any setting of the instrument controls but ANSI S3.22 requires that certain settings be used. See ANSI S3.22-2003 facts and ANSI S3.22-2009 facts. The [Input/Output] test allows you to generate up to 4 separate input/output curves at each of 5 individual frequencies (250, 500, 1000, 2000, 4000 Hz) as provided in ANSI S3.22.

1. Press <Tests>, then highlight and <PICK> [Test box measures], then highlight and <PICK> [Input/Output].
2. Refer to Coupling the hearing instrument, Positioning the hearing instrument and Battery pill use and care to prepare the instrument for testing.
3. Turn the instrument ON; set AGC controls or programming parameters as in ANSI or ANSI / IEC tests
4. Highlight and <PICK> [Curve 1]. Test setup instructions will be displayed.
5. Press <Continue> to generate a set of 5 input/output curves.
6. To measure another set of 5 input/output curves, highlight and <PICK> another [Curve #].
7. To summon a cursor to determine curve values, position the mouse pointer on a graph area and click the left mouse button. Click again to turn it off.

**NOTE:** Noise in the test area may cause erroneous results at low input levels (particularly at 250 and 500 Hz). Ensure that the test box is well sealed and ambient noise is low.

## ANSI telecoil terminology

The RM500SL test chamber contains an integrated telephone magnetic field simulator (TMFS) meeting the requirements of ANSI S3.22, that enable the measurement of coupler SPL produced by a hearing instrument with a telephone pickup coil. ANSI uses the following terms in telecoil testing:

**RTG** (reference test gain) is the average gain measured with the gain control in the reference test setting. See ANSI S3.22-200x facts.

**TMFS** (Telephone magnetic field simulator). A 38.4-mm diameter coil spaced 16.5 mm below a test surfaced driven by a specified test signal. Intended to simulate a telephone handset receiver.

**SPLITS** (Coupler SPL for an inductive telephone simulator). SPL developed in a 2cc coupler by a hearing instrument with the gain control in the RTS when the input is the magnetic field generated by a TMFS.

**HFA (or SPA) –SPLITS.** Average of the SPLITS at HFA or SPA frequencies.

**RSETS** (relative simulated equivalent telephone sensitivity) is calculated as HFA SPLITS minus (RTG + 60). A positive RSETS indicates greater output when using the telephone than when using the microphone.

## ANSI telephone simulator (TMFS) test

ANSI S3.22 requires that the gain control be set to RTS before running this test. The reference test gain (RTG) is required in order to calculate the RSETS. The easiest way to meet both requirements is to run a [ANSI] or [ANSI / IEC] test before running this test. See ANSI 2003 and ANSI / IEC tests.

1. First, complete an [ANSI] or [ANSI / IEC] test, then press <Tests>.
2. Highlight & <PICK> [Test box measures], then highlight and <PICK> [Telecoil].
3. Set the aid to 'T' (telecoil input).
4. Highlight and <PICK> [Start TMFS test]. Test setup instructions are displayed.
5. Position the aid on the 'T' inscribed on the test chamber floor. BTE aids should lie as flat as possible on the test chamber surface, while custom aids should be oriented with their faceplate parallel to the top surface (if possible) and touching it as shown.



6. Press <Continue> to start the test.
7. While maintaining the orientation of step 5, move the hearing instrument around on the test chamber surface to maximize the number shown in the 'Maximize Average-SPLITS Value' box.
8. Without moving the hearing instrument, press <Continue> to store the Average HFA SPLITS value and run the SPLITS curve.

If an RTG has been previously obtained, the RSETS will be shown.

## Telecoil test results

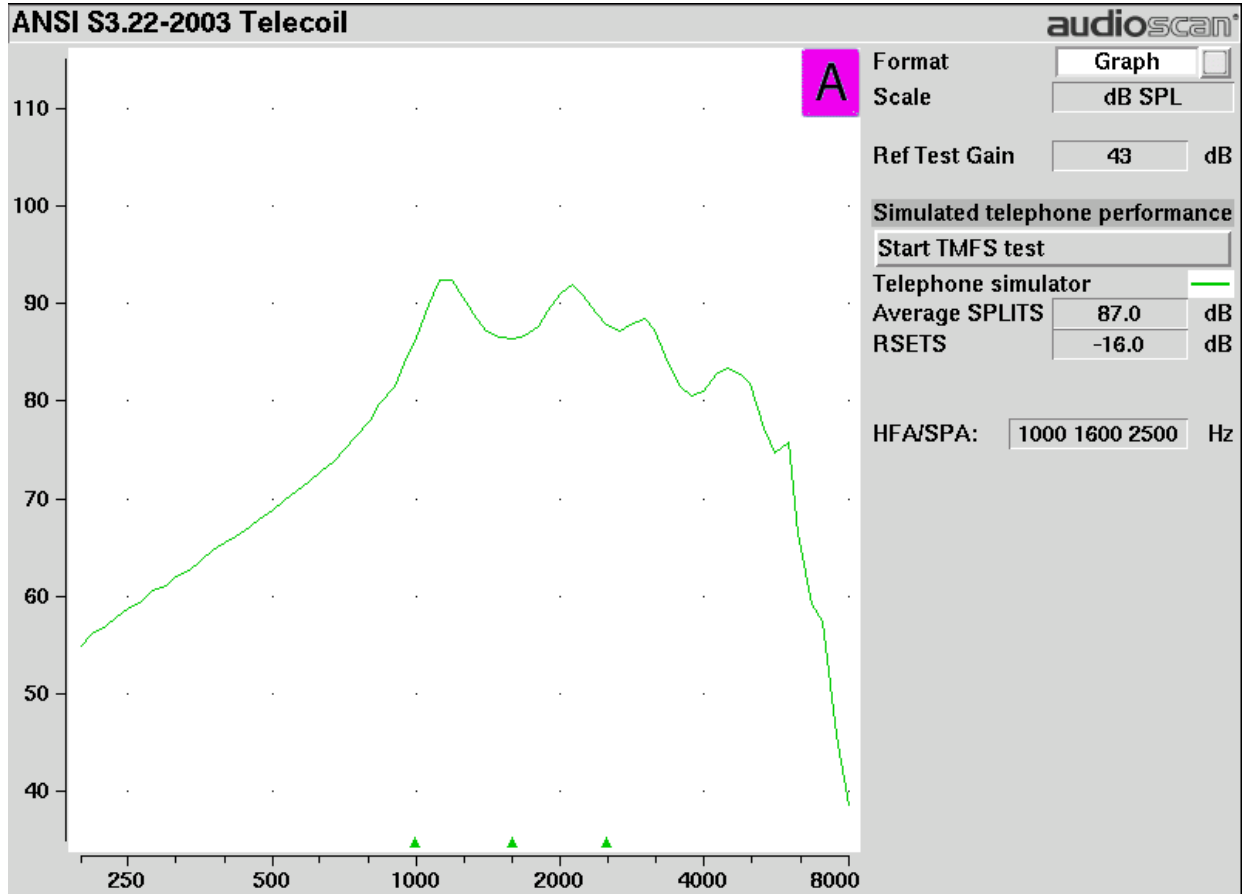

## 10 Other Test Box Measures

In addition to the tests of ANSI S3.22, the RM500SL also provides the following tests in the test box:

**Manual control:** Coupler and test box reference mic. SPL and coupler mic. distortion at selected 1/12th octave frequencies and stimulus SPL of 0 and 40 – 90 dB in 5 dB steps. Can be used as a dual channel sound level meter with 1/12th octave, A and C filters.

**Distortion:** Harmonic distortion at 2nd or 3rd harmonics and 2nd plus 3rd with input levels varying from 60 – 90 dB SPL.

**Multicurve:** 1 – 4 curves of coupler SPL or coupler gain for swept tones or pink noise in 1/12th octaves at selected input SPL of 0 or 40 to 90 dB in 5 dB steps. Can be used as a 1/12th octave spectrum analyzer by setting stimulus to 0 dB.

**Battery drain:** A 10 second test of battery current drain with no acoustic input, a 1 kHz 65 dB input SPL, and an average for 90 dB input SPL at the HFA or SPA frequencies selected in Setup.

### Harmonic distortion

This test measures harmonic distortion at 2nd or 3rd harmonics with input levels varying from 60 – 90 dB SPL. It also presents the sum of 2nd and 3rd harmonics as total harmonic distortion (THD). For hearing aids, this differs little from true THD.

1. Press <Tests>, then highlight and <PICK> [Test box measures], then highlight and pick [Distortion].
2. Refer to Coupling the hearing instrument, Positioning the hearing instrument and Battery pill use and care to prepare the instrument.
3. Turn the hearing instrument ON.
4. Highlight and <PICK> [Start test].
5. Highlight and <PICK> [Harmonics], then highlight and <PICK> THD, 2nd or 3rd from the drop-down list.
6. Highlight and <PICK> [Input], then highlight and <PICK> the desired input level (60 – 90 dB SPL) from the drop-down list.
7. Press <Continue> to run the test. Distortion will be displayed at 1/3 octaves in graphic and in tabular form.

### Noise reduction

This test captures a response curve before the hearing instrument reacts to the presence of noise; a comparison curve shows the hearing instrument reacting in real-time. The thick curve is the output before the noise reduction is activated and the thin line is the output as the noise reduction takes effect. The test also provides an overall rms noise reduction value in dB.

1. Press <Tests>, then highlight and <PICK> [Test box measures], then highlight and pick [Noise reduction].
2. Highlight and <PICK> Test 1, 2 or 3.
3. Highlight and <PICK> a stimulus type from the list box.
4. Highlight and <PICK> a stimulus level from the list box.
5. Highlight and <PICK> [Start test]
6. Highlight and <PICK> [Continue] to capture the comparison curve once the noise reduction function has



responded.

## Multicurve procedure

Multicurve generates 1 to 4 output or gain response curves using either pink noise or swept pure tones at input levels ranging from 40 – 90 dB SPL and 0 dB (off).

1. Press <Tests>, then highlight and <PICK> [Test box measures], then highlight and <PICK> [Multicurve].
2. Refer to Coupling the hearing instrument, Positioning the hearing instrument and Battery pill use and care to prepare the instrument for testing.
3. Turn the instrument ON.
4. Highlight and <PICK> button 1, 2, 3 or 4 in the Test column.
5. Highlight and <PICK> the Stimulus window, then highlight and <PICK> either [Pink noise] or [Swept] from the drop-down list.
6. Highlight and <PICK> the Level window for the selected Test, then highlight and <PICK> a stimulus level from the drop-down list.
7. Press <Continue> to run a sweep or to capture a pink noise curve; press <Cancel> to abort the test.
8. To measure another response curve, highlight and <PICK> another test button; to overwrite a curve, highlight and <PICK> its test button.

To change scale from dB SPL to dB Gain, highlight & <PICK> the Scale window.

## Multicurve results

1. *Output* curves for the noise signal are in 1/12th octave bands. They will be approximately 18 dB lower than pure tone curves for a linear instrument.
2. *Gain* curves for a linear instrument will be the same for both swept and pink noise test signals.
3. For compression instruments, both gain and output curves may be expected to differ for the two test signals.
4. See Test Box Measures - Setup to change screen appearance.

## Spectral analysis in Multicurve

Selecting a stimulus level of 0 dB (off) in [Multicurve] presents a spectral analysis of the coupler microphone signal (Scale = dB SPL) or the difference between the coupler and reference microphone spectra (Scale = dB Gain).

If the stimulus type is [Pink noise], the analysis is performed in 1/12th octave bands and displayed in real time. Pressing <Continue> captures the displayed spectrum.

If the stimulus type is [Swept], a swept filter analysis is performed in 1/12th octave bands and displayed at 1/3rd octave frequencies. Pressing <Continue> causes the swept filter analysis to be performed in 1/12th octave bands

and displayed at 1/12th octave frequencies.

## Battery drain test

The battery drain test automatically measures the battery current when there is no input signal (quiescent), when the input signal is a 1 kHz tone at 65 dB SPL and the average of the currents when the input signal is 90 dB SPL at the HFA or SPA frequencies (Avg @ 90 dB). Battery life is estimated assuming 80% quiescent and 20% Avg @ 90 dB use. With the hearing instrument set as normally used:

1. Install and connect the proper battery pill. See Battery pill use and care
2. Press <Tests>, then highlight and <PICK> [Test box measures], then highlight and <PICK> [Battery drain].
3. Highlight and <PICK> [Battery type] and select from drop-down list.
4. Highlight and <PICK> [Hours per day] and select from drop-down list.
5. Highlight and <PICK> [Start test]

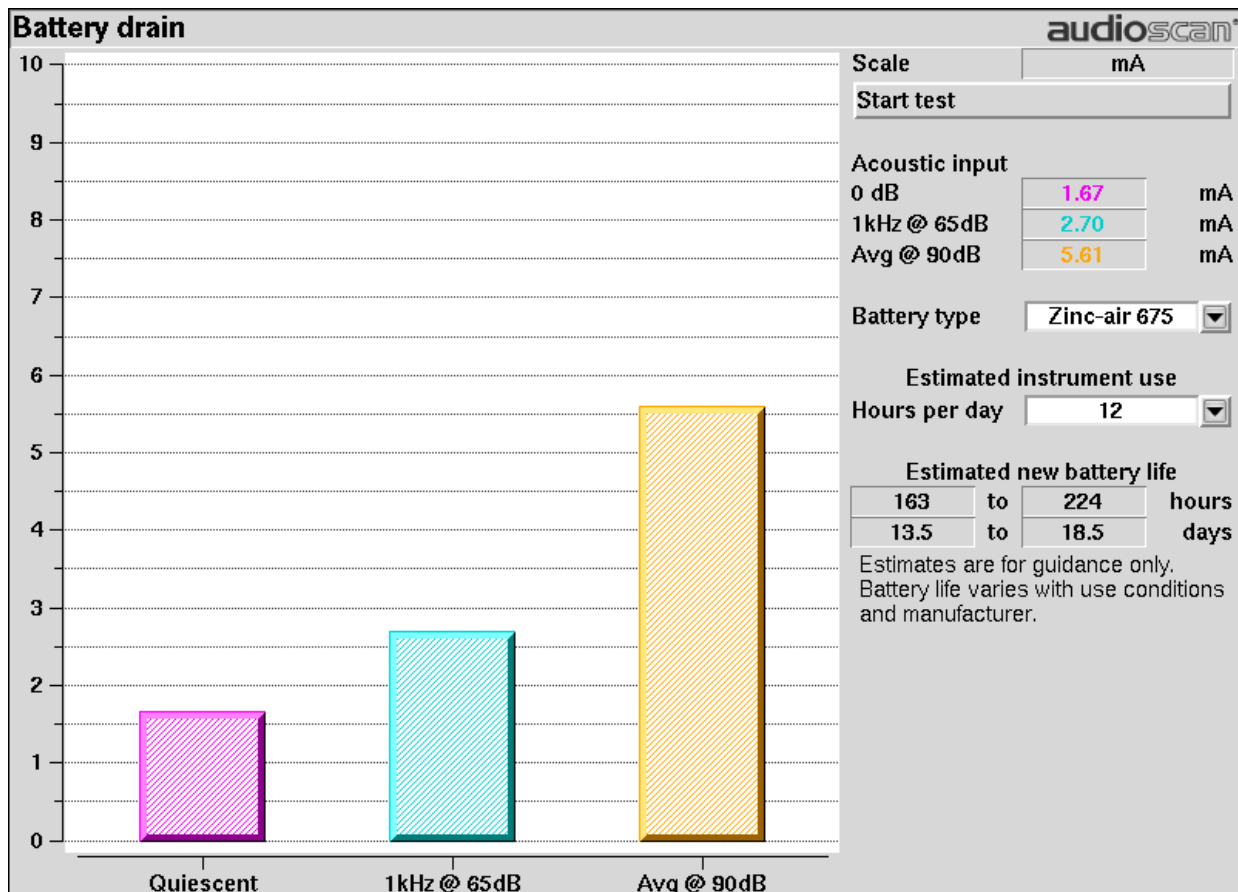

## Manual control procedure

Manual control displays the reference microphone SPL, the coupler microphone SPL, their difference in dB (gain) and coupler microphone signal distortion at any selected 1/12th octave frequency and at a selected input level from 40 to 90 dB (in 5 dB steps) and at 0 dB (off).

1. Press <Tests>, then highlight and <PICK> [Test box measures], then highlight and <PICK> [Manual control]

2. Highlight and <PICK> the Level window, then highlight and <PICK> the desired stimulus level from the drop-down list.
3. Highlight and <PICK> the Frequency window, then highlight and <PICK> the desired frequency from the drop-down list. (Distortion measurement data is available only from 200-4000 Hz.)
4. Highlight and <PICK> [Start test] to start the test. [Start test] changes to [Stop Test]. To stop the measurement, highlight and <PICK> [Stop test]. You may change Level and Frequency without stopping the test.

## Sound level meter using manual control

When set for a stimulus level of 0 dB (off), the Manual control mode allows the RM500SL to be used as a sound level meter. Sound at the test box reference microphone and the coupler microphone may be analyzed by 1/12th octave, A-weighted or C-weighted filters. A and C-weighted measurements are limited to frequencies above 100 Hz and the averaging time and update rate are 384 ms.

1. Press <Tests>, then highlight and <PICK> [Test box measures], then highlight and <PICK> [Manual control].
2. Highlight and <PICK> the Level window, then highlight and <PICK> 0 dB stimulus level from the drop-down list.
3. Highlight and <PICK> the Filter window, then highlight and <PICK> 1/12th octave, A-weighted, or C-weighted from the drop-down list.
4. For 1/12th octave filter, highlight and <PICK> the Frequency window, then highlight and <PICK> the desired frequency from the drop-down list.
5. Highlight and <PICK> [Start test] to start the test. [Start test] changes to [Stop Test]. To stop the measurement, highlight and <PICK> [Stop test]. You may change Level and Frequency without stopping the test.

**NOTE:** *Microphone extension cables (VA-131 & VA-133) are available from Audioscan. Standard audio extension cables should not be used. They will substantially increase noise levels.*

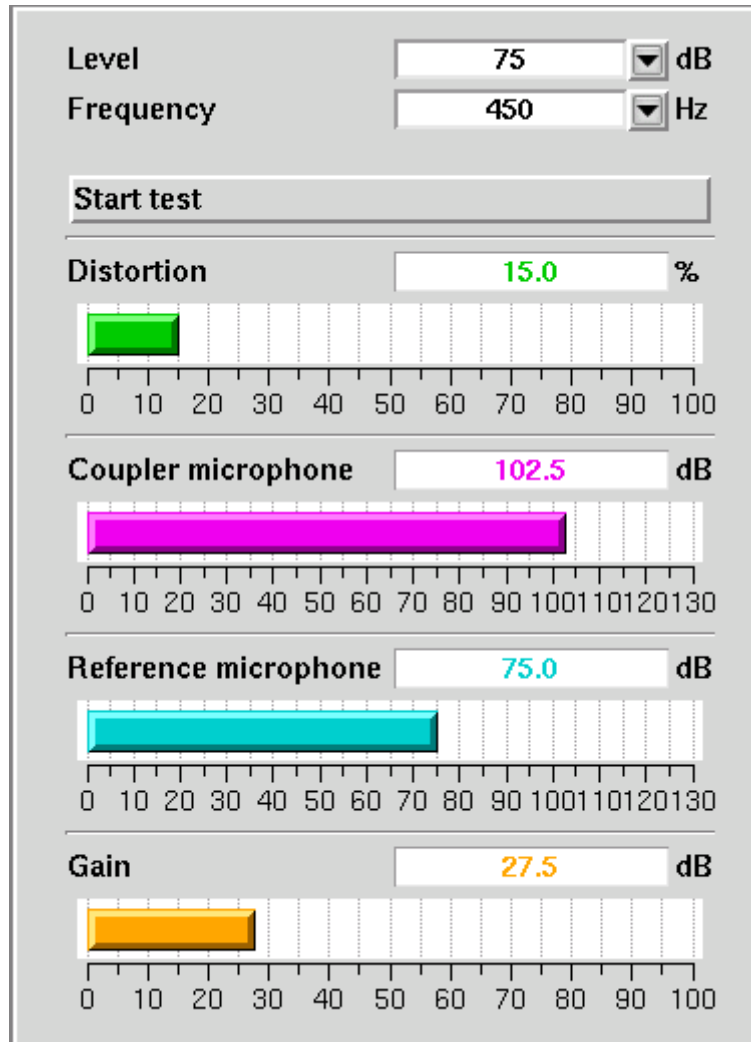

# 11 Sensory loss simulator

## Sensory loss simulator description

A pure conductive loss attenuates loud and soft sounds equally, and is easily simulated by just turning down the volume or inserting an earplug. Losses of a sensory nature are more complex and more difficult to simulate.

The most common sensory loss is caused by *outer hair cell* damage and results in loss of audibility for soft sounds but near-normal loudness for loud sounds. *Inner hair cell* damage elevates threshold and reduces loudness for both soft and loud sounds, possibly somewhat more for soft sounds.

This sensory loss simulator (SLS) is intended to allow normal-hearing listeners to hear sounds as if they had the elevated threshold and altered loudness perception caused by outer and inner hair cell damage. It is based on the cochlear hearing loss model described in Moore & Glasberg (2004).

In this simulation, losses less than 58 dB SPL are considered to be due entirely to outer hair cell damage. Any loss greater than this is considered inner hair cell loss.

This SLS does not simulate broadening of the auditory filters or other distortions that may accompany cochlear hearing loss.

To properly experience the simulation, listeners should be within 1m of the sound-field speaker and in a quiet room.

## Sensory loss simulator operation

*Listeners should be within 1m of the sound-field speaker and in a quiet room.*

1. Press <Tests>, then highlight and <PICK> [Sensory loss simulator].
2. If an audiogram has previously been entered in Speechmap or Insertion gain, go to step 4. Otherwise, highlight and <PICK> [Audiometry].
3. Enter HL threshold values using a mouse or the keypad. Left click the mouse on the audiogram form to enter a point. Click again to delete the point. On the keypad use the arrow keys to change frequency and level and press <PICK> to enter or delete a threshold point.
4. Press <Continue> when all points have been entered. See Audiometric data entry or Assessment data entry for more details.
5. Highlight and <PICK> [Start test]. Sound, processed to simulate the entered hearing loss, will be presented via the sound-field speaker.
6. Highlight and <PICK> [Stimulus], then highlight and <PICK> a sound to play.
7. Highlight and <PICK> [Hearing], then highlight and <PICK> from [Normal, ½ Entered loss, Entered loss].
8. Highlight and <PICK> [Type of loss] to toggle between [Sensorineural] and [Conductive] hearing loss simulations.
9. Highlight and <PICK> [Cancel] to stop the simulation.

## 12 On-Ear Measures - Setup

For accurate, repeatable measurements, the RM500SL must be properly set up and calibrated, the client must be properly positioned and the probe tube must be properly positioned in the ear canal. Some common terms:

Real-Ear Unaided Response (*REUR*): SPL, or band SPL, in the open (unaided) ear canal for a given stimulus.

Real-Ear Unaided Gain (*REUG*): Difference, in dB, between the REUR and the stimulus SPL, or stimulus band SPL.

Real-Ear Aided Response (*REAR*): SPL, or band SPL, in the ear canal for a given stimulus, with a working hearing aid in place.

Real-Ear Aided Gain (*REAG*): Difference, in dB, between the REAR and the stimulus SPL, or stimulus band SPL.

Real-Ear Saturation Response (*RESR*): The REAR obtained using a narrow-band signal at a level high enough to saturate the hearing aid (usually 85 - 90 dB SPL).

Real-Ear-to-Coupler Difference (*RECD*): Difference, in dB, between the SPL produced in the ear canal and the SPL produced in a coupler by the same sound source.

### On-ear calibration facts

The probe microphone and its associated tubing does not have a flat frequency response. The on-ear calibration process compares this response with the flat, factory-calibrated response of the on-ear reference microphone and compensates all subsequent probe-tube measurements for this difference. It may be performed as often as desired but will be invalidated at 12 am the following day or at 12 am the following Monday, depending on the choice of Daily or Weekly calibration interval. After the calibration has expired, you will be prompted to calibrate whenever you attempt a test that uses the on-ear measurement microphones.

It is suggested that a copy of the calibration curves for the probe modules when new be posted near the RM500SL for comparison with daily or weekly curves. If there is a drift in calibration with time, the module may need replacement. See Calibration check for probe module.

Calibration should be repeated if a probe module is replaced or if a probe-tube with different dimensions is installed.

### Calibration of on-ear probe microphone

Ensure the probe microphone assembly to be calibrated is plugged into the appropriate jack. See Microphone connection and On-ear calibration facts

1. Press <Tests>, then highlight & <PICK> [On-ear measures], then highlight & <PICK> [Calibration].
2. Press the enlarged end of a probe tube as far as it will go, into the recessed opening at the top of the probe module.
3. Position the open end of the probe tube in front of the reference microphone inlet and press it between the posts as shown.

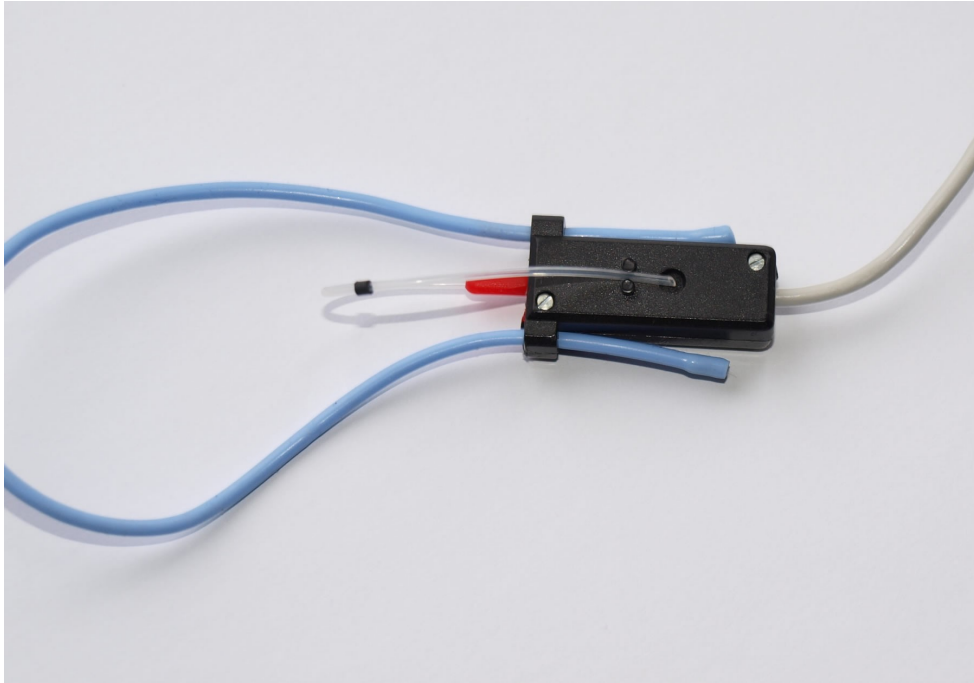

4. Hold the probe module 15 - 90 cm (6 – 36 inches) away from and directly in front of the sound-field loudspeaker. Orientation of the probe module is not critical.
5. Press <PICK> to calibrate. The resulting curve should be similar in shape to that shown but may be shifted +/- 5 dB.
6. To change the calibration interval, highlight & <PICK> [Daily] or [Weekly].

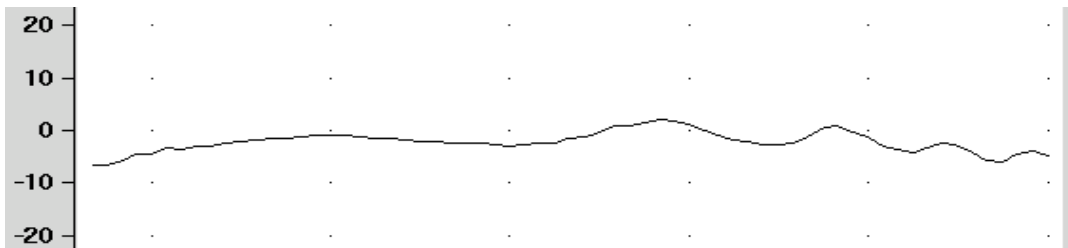

## Calibration check for probe module

The calibration curve for the probe module is a comparison of the response of the probe microphone (with tube) to the response of the on-ear reference microphone. Any change in the curve indicates a change in one of these microphones (or the probe tube). See Calibration of on-ear probe microphone. As part of a regular calibration schedule, or to investigate changing calibration curves, the on-ear reference microphone may be checked against a high quality sound level meter.

1. Press <Tests>, then highlight and <PICK> [On-ear measures], then highlight and <PICK> [Manual control].
2. Highlight & <PICK> [Level], then highlight & <PICK> 70 from the drop-down list.
3. Highlight and <PICK> [Frequency], then highlight and <PICK> 2000 Hz from the drop-down list.
4. Highlight, then <PICK> [Start test] (which changes to [Stop test]).

5. Hold the probe module about 18 in. (0.5 m) in front of the sound-field speaker.
6. Hold the microphone of a calibrated sound level meter next to the on-ear reference microphone as shown. Set the sound level meter to C weighting and slow.
7. The sound level meter should read  $70 \pm 2$  dB.
8. Repeat with the frequency at 250 Hz.
9. To stop the measurement, highlight and <PICK> [Stop test].

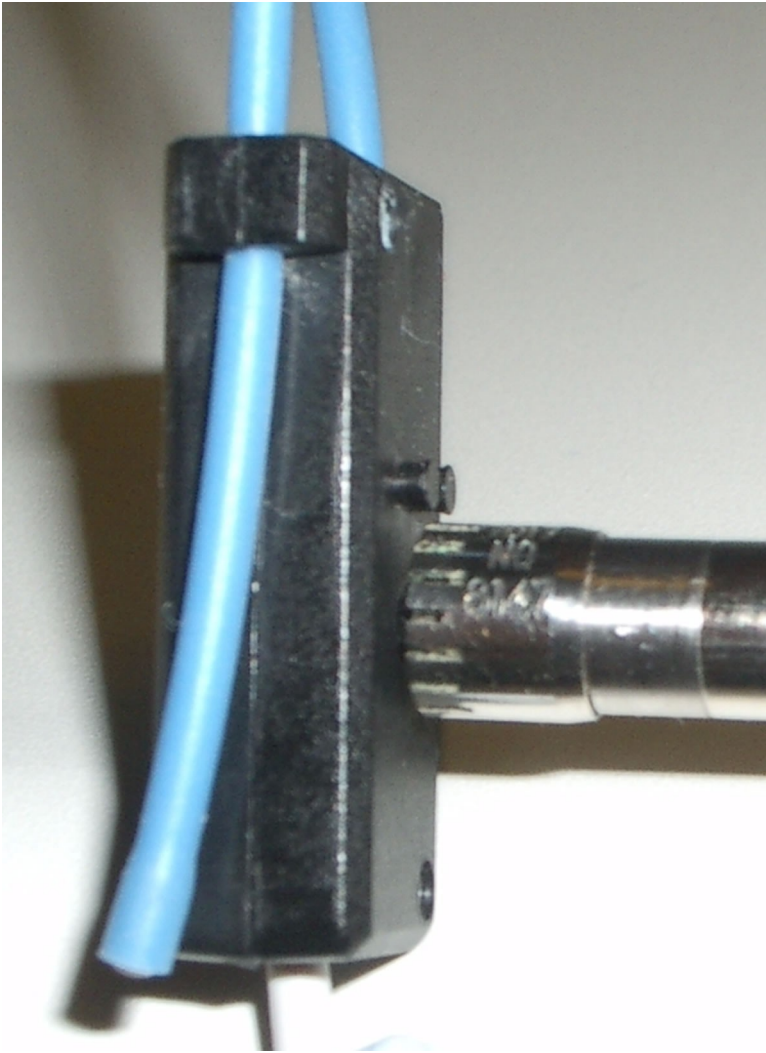

*The probe module should be replaced if it fails this test.*

## **Max TM SPL setup**

The Max TM SPL safety feature allows you to set a limit on the SPL, measured by the probe microphone, above which a test terminates. The MAX TM SPL limit is shown on all on-ear measurement screens. The default limit is 120 dB.



To choose a different Max TM SPL setting:

1. Press <Setup>, then highlight and <PICK> [Max TM SPL].
2. Highlight and <PICK> the current Max TM SPL setting.
3. Highlight and <PICK> the desired Max TM SPL setting from the drop-down list.
4. Press <Continue> to exit Setup.

*This Max TM SPL setting will be in effect until you change it.*

If the limit is exceeded during an on-ear test, the RM500SL will terminate the test and display the message 'MAX TM SPL EXCEEDED'. You must then decide to either reduce the maximum output limit of the hearing instrument or increase the Max TM SPL setting following the steps above.

If the MAX TM SPL limit has been disabled, a notice will appear on each real-ear screen. Also, a message reminding you that the MAX TM SPL limit has been disabled will appear when you select an on-ear test.

## ABR nHL to eHL setup

**Estimated Hearing Level (eHL):** An estimate of the behavioral pure tone threshold that accounts for a measured ABR threshold.

**Normalized Hearing Level (nHL):** (a) Stimulus peak-to-peak equivalent SPL (pe SPL) at ABR threshold relative to the average stimulus pe SPL at ABR threshold of a normal-hearing jury OR (b) stimulus SPL at ABR threshold relative to the average stimulus SPL at behavioral threshold of a normal-hearing jury for the same stimulus. (Note that in this latter case, nHL is equivalent to eHL).

In Speechmap/DSL you have the option of entering ABR thresholds in either eHL or nHL. If eHL is selected, the threshold is treated as if it were a behavioral pure-tone threshold. If nHL is selected, the entered data will first be converted to eHL before SPL threshold and fitting targets are calculated. To do this, appropriate eHL to nHL conversion factors must be applied. You can choose to apply default conversion factors or enter new ones for each client.

This setup allows you to select the *default* conversion factors that are applied in Speechmap/DSL to convert ABR nHL threshold to eHL threshold.

1. Press <Setup>, then highlight and <PICK> [ABR eHL to nHL].
2. Highlight and <PICK> [DSL defined] or [User defined]
3. For [User defined], enter conversion factors using a mouse, the keypad or a keyboard. See Assessment data entry.

When using the barcode option, both entered nHL data and the nHL to eHL conversion factors are printed as a single barcode. See Barcode data input.

## Positioning the client



**WARNING:** Probe tubes are for single-patient use only. Care is required when sliding the probe tube into the ear canal. Be careful not to advance the probe tube further into the ear canal when inserting an earmold or custom hearing instrument into the ear or when inserting the foam tip into the ear

Sound reflections from nearby surfaces (including the operator) can cause large measurement errors, especially if the client moves between REUR and REAR measurements. Room noise can increase test time, cause errors and alter the operation of the hearing instrument being evaluated.

1. Choose a quiet location and position the client and the sound-field speaker at least 1.5 m (5 feet) away from any hard surfaces.
2. Position the client directly in front of, and facing, the sound-field speaker at a distance of 45 to 90 cm (18 to 36 in.) from the center of the head.

## Positioning the probe tube



**WARNING:** Probe tubes are for single-patient use only. Care is required when sliding the probe tube into the ear canal. Be careful not to advance the probe tube further into the ear canal when inserting an earmold or custom hearing instrument into the ear or when inserting the foam tip into the ear

1. Use an otoscope to ensure there is no ear canal obstruction (e.g. cerumen) and to get a sense of ear canal length.
2. Install a new probe tube on the probe module. Set the black marker ring approximately 28 mm from end of probe tube for adult females, approximately 30 mm from end of probe tube for adult males and approximately 20-25 mm from end of probe tube for children. These positions may be modified based on the otoscopic examination. (Tip - the probe module body is 28 mm long.)
3. Hang the probe module on the ear, as shown. *The reference microphone should face outwards.*
4. Adjust the blue cord until the probe module is snug against the head, directly below the earlobe (cheek level). To facilitate this, clip the probe module cable to clothing on the side opposite the test ear and draw the cable snug.
5. Hold the front blue cord so that it passes behind the ear canal entrance and pass the end of the probe tube in front of the blue cord and into the ear canal.
6. Carefully slide the probe tube into the ear canal until the marker ring approaches the intertragal notch. Then let the front blue cord move forward to hold the probe tube in place. Use an otoscope to verify that the tube is 2 to 5 mm from the eardrum.



Probe tube insertion: The blue lanyard holds the tube in place and the depth marker is at the intertragal notch

## 13 On-Ear Measures Screen Setup

To accommodate your working preferences, the appearance of On-ear measurement screens may be changed in several ways.

### On-ear right or left display

The RM500SL can retain and display On-ear test results for two ears. To switch between left and right test results, press the <Left/Right> key.

### Graph, table or 2cc target format

Most on-ear test screens may be viewed in graphic or tabular format.

- In RECD and Directional tests, highlight and <PICK> [Format] to toggle between [Graph] and [Table] views.
- In Speechmap and Insertion gain, highlight and <PICK> [Format], then highlight and <PICK> [Graph], [Table] or [2cc targets] from the drop-down list.
- In [2cc targets] format, reserve gain and fitting formula may be changed. Highlight & <PICK> the appropriate window, then highlight & <PICK> the reserve gain or fitting formula from the drop-down list.

In Speechmap, if DSL or NAL-NL1 has been selected as a target method, then 2cc coupler targets for user gain, full-on gain and OSPL90 are provided. The full-on gain is just the user gain plus the reserve gain. If no target method has been selected, only 2cc OSPL90 values are indicated. *Target gains are for speech-like signals at a 70 dB input SPL; OSPL90 targets are for 90 dB pure tones.*

On-ear targets are converted to 2cc coupler values by using age-appropriate average or measured (if available) RECD values and the appropriate microphone location effects for the desired style of hearing instrument.

The gain values given assume the hearing instrument is linear for a 70 dB speech input. This assumption is necessary to allow the microphone location effects to be incorporated.

For BTE and body aids, the 2cc coupler values provided assume a fully-occluding earmold with #13 tubing extending to the medial tip of the earmold and a "standard" canal length. If a different type of mold is used, alterations to these values should be made to account for the different acoustic characteristics. For CIC instruments, the 2cc values take into account that the instrument, when deeply inserted into the ear canal, will produce a greater SPL in the ear than that measured in the ITE coupler.

### SPL or HL scale

In Speechmap and Insertion gain tests you may view results in either dB HL or dB SPL.

**Insertion gain tests** view the hearing aid as improving the sound-field threshold. In Insertion gain, the HL scale presents aided results as improved sound-field thresholds while the speech region remains fixed.

**Speechmap tests** view the hearing aid as increasing the ear canal SPL. Speech gets louder but the threshold remains fixed. On the HL scale in Speechmap, normal ear canal threshold becomes the 0 dB HL line and all data is replotted using this reference. A physical interpretation of the data is difficult and the use of *HL in Speechmap is not recommended*. All instructions given in this guide assume the SPL Speechmap scale.

To change the scale:

Highlight and <PICK> [Scale] to toggle between a dB SPL and dB HL scale.

## Hide or show on-ear curves

To hide or show test curve(s):

1. Highlight, then <PICK> Curve [Hide/Show].

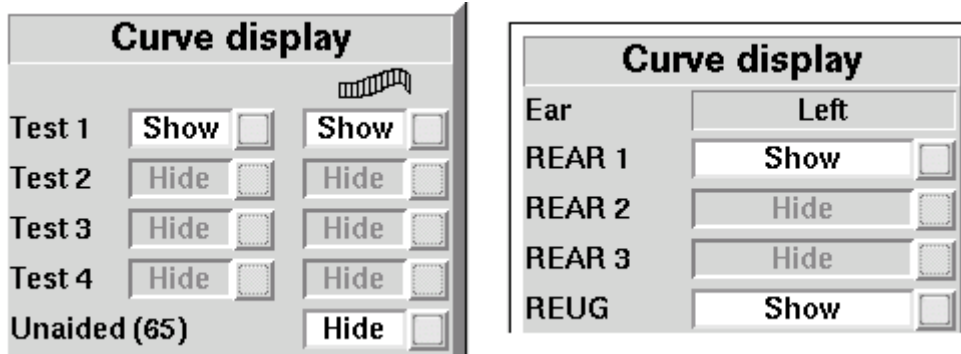

2. Highlight, then <PICK> the desired test to toggle between the Hide or Show options. The curve will toggle on or off when selected. The envelope of speech curves in Speechmap may be displayed or hidden for clarity of display by toggling the buttons under the  column. Note that you may set the envelope to automatically hide whenever a new test is run (see Speechmap – Speechmap Setup).
3. Press <Continue> to return to the test screen.

Hiding a curve does not erase it. To erase curves use the <Session> key.

## 14 On-Ear Instrument Measures

A number of the tests covered in Test box measures can also be performed with the hearing instrument coupled to the ear of a client rather than to a 2cc coupler. The on-ear results may be expected to differ from the test box results because of the different acoustic environment and the different acoustic load.

### On-ear feedback test

This test shows the LTASS (upper graph) and the power concentration ratio (PCR) (lower graph) for a speech signal. The PCR measures the degree to which a large amount of power is concentrated at a small number of frequencies in the hearing aid output (see Freed & Soli in [References](#)). In the RM500SL, the PCR is the ratio of the average power of the dominant frequency components in a 1/12 octave band to the power in the entire band, expressed in dB. Because the gain of a compression hearing aid varies with the signal it is processing, the PCR is calculated in real time while a speech signal is presented to the hearing aid. The upper graph shows the LTASS for the speech signal while the lower graph shows the PCR relative to the PCR for speech without feedback. Feedback results in a peak in the speech spectrum and in the PCR. Incipient feedback results in a peak in the PCR curve.

Refer to [On-Ear Measures - Setup](#) to prepare the system for use and for proper positioning of the client and the probe tube.

1. Insert the earmold/tip or custom hearing instrument into the ear, being careful not to advance the probe tube further into the ear canal. A lubricant applied in the vicinity of the probe tube will ease insertion and prevent slit leaks.
2. Set the instrument as it will be used, with feedback suppression enabled and initialized.
3. Press <Tests> then highlight and <PICK> [On-ear measures], then highlight and <PICK> [Feedback].
4. Highlight and <PICK> Test 1 and set the Stimulus to Speech-std(1) or (2) and the level to 50 or 60 dB SPL. As the speech passage plays, observe the feedback bar and the lower graph. A yellow Feedback bar and peaks with yellow markers in the lower curve indicate incipient feedback which may impact sound quality. A red Feedback bar and peaks with red markers in the lower curve indicate feedback that may be audible and should be mitigated. Press <Continue> to run the full speech passage and capture average results for the passage.
5. Repeat for Test 2 and 3 as needed. These tests may be used to explore the effects of jaw movement and the presence of hands, hats and telephone handsets.

### On-ear noise reduction test

This test captures a response curve before the hearing instrument reacts to the presence of noise; a comparison curve shows the hearing instrument reacting in real-time. The thick curve is the output before the noise reduction is activated and the thin line is the output as the noise reduction takes effect. The test also provides an overall rms noise reduction value in dB.

Refer to [On-Ear Measures - Setup](#) to prepare the system for use and for proper positioning of the client and the probe tube.

1. Press <Tests>, then highlight and <PICK> [On-ear measures], then highlight and pick [Noise reduction].
2. Highlight and <PICK> Test 1, 2 or 3.
3. Highlight and <PICK> a stimulus type from the list box.

4. Highlight and <PICK> a stimulus level from the list box.
5. Highlight and <PICK> [Start test]
6. Highlight and <PICK> [Continue] to capture the comparison curve once the noise reduction function has responded.

## On-ear manual control

1. Refer to On-Ear Measures - Setup to prepare the system for use and for proper positioning of the client and the probe tube.
2. Press <Tests>, then highlight and <PICK> [On-ear measures], then highlight and <PICK> [Manual control].

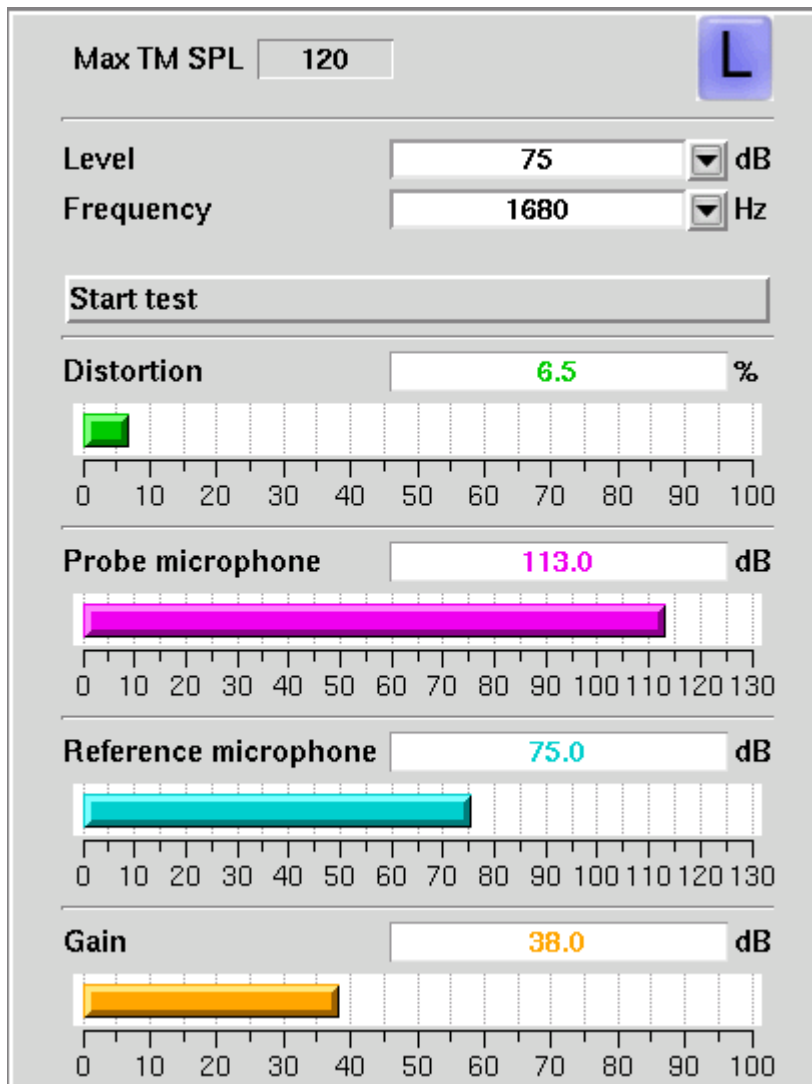

3. Highlight and <PICK> the Level window, then highlight and <PICK> the desired stimulus level from the drop-down list.
4. Highlight and <PICK> the Frequency window, then highlight and <PICK> the desired frequency from the drop-down list. (Distortion measurement data is available only from 200-2500 Hz.)

5. Highlight and <PICK> [Start test] to start the test. [Start test] changes to [Stop Test]. To stop the measurement, highlight and <PICK> [Stop test]. You may change Level and Frequency without stopping the test.

## Sound level meter using on-ear microphones

The manual control feature enables the RM500SL to be used as a sound level meter to perform C-weighted, A-weighted or 1/12th octave analysis of sound as measured by the probe and reference microphones. A and C-weighted measurements are limited to frequencies above 100 Hz and the averaging time and update rate are 384 ms.

1. Refer to On-Ear Measures - Setup to prepare the system for use and for proper positioning of the client and the probe tube.
2. Press <Tests>, then highlight and <PICK> [On-ear measures], then highlight and <PICK> [Manual control].
3. Highlight and <PICK> the Level window, then highlight and <PICK> 0 dB stimulus level from the drop-down list.
4. Highlight and <PICK> the Filter window, then highlight and <PICK> 1/12th octave, A-weighted, or C-weighted from the drop-down list.
5. For 1/12th octave filter, highlight and <PICK> the Frequency window, then highlight and <PICK> the desired frequency from the drop-down list.
6. Highlight and <PICK> [Start test] to start the test. [Start test] changes to [Stop Test]. To stop the measurement, highlight and <PICK> [Stop test]. You may change Level and Frequency without stopping the test.



# 15 Occlusion Effect Test

The occlusion effect refers to the unnatural sound of one's own voice that results from occluding the external ear. It is the result of the high SPL produced at the back of the throat during a closed vowel utterance coupling to the closed ear canal via bone conduction. Ear canal levels in a closed ear canal can exceed 90 dB SPL for closed vowels such as 'ee'. The effect is greatest below 1000 Hz. Clients with mild-moderate low frequency hearing loss may describe their own voice as sounding 'hollow' or as if they were talking 'in a barrel'.

The occlusion effect is measured by comparing the SPL in the ear canal to that outside the external ear while the client vocalizes 'ee' with the hearing aid in place and turned off. Differences greater than 10 dB may result in complaints. This occlusion effect measurement is useful in quantifying the extent to which venting or deep insertion is addressing the underlying cause of the complaint.

## Occlusion effect measurement

1. Refer to On-Ear Measures - Setup to prepare the system for use and for proper positioning of the client and the probe tube.
2. Insert the earmold or custom hearing instrument into the ear, being careful not to advance the probe tube further into the ear canal. A lubricant applied to the earmold or custom instrument shell in the vicinity of the probe tube will make insertion easier and prevent slit leaks around the tube.
3. Turn the hearing aid OFF.
4. Press <Tests>, then highlight and <PICK> [On-ear measures], then highlight and <PICK> [Occlusion].
5. Highlight and <PICK> [Start test]. [Start test] changes to [Stop Test].
6. While the client vocalizes 'ee' in a normal voice, highlight and <PICK> [Stop test] to stop the test and freeze the screen. A red occlusion bar indicates an occlusion problem, a yellow bar indicates a possible problem and a green bar indicates no problem.
7. Increase venting and repeat the test until a green bar is obtained.

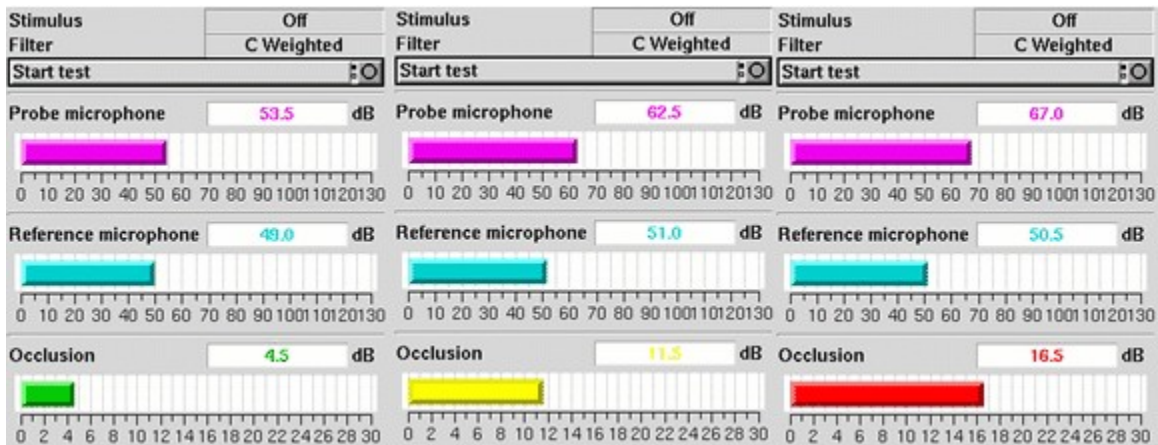

## 16 RECD measurement

The RECD (real-ear to coupler difference) may be individually measured to improve the accuracy of hearing aid fittings. The measurement procedure may be accessed by selecting RECD from the *On-ear tests* list or from the Audiometry poster within *Speechmap*.

### Calibration of RECD transducer



**WARNING:** Foam eartips are for single-patient use only



**WARNING:** The RECD transducer may be adversely affected if it comes in contact with a magnet. Do not store where it may come in contact with any permanent magnet. If contact with a magnet is suspected, transducer re-calibration is recommended prior to any patient measurements,

RECD values are stored and expressed as referenced to the HA-1 (ITE) coupler, however for ease of measurement we calibrate the RECD transducer in the HA-2 (BTE) coupler.

1. Connect the (optional) RECD transducer to the RECD jack to the left of the test chamber. Prepare the system for test box tests. See [Microphone connection](#), [Calibrating test box reference microphone](#).

Prepare the system for test box tests. See [Microphone connection](#), [Calibrating test box reference microphone](#).

2. Press <Tests> then highlight and <PICK> [On-ear measures], then highlight and <PICK> [RECD].

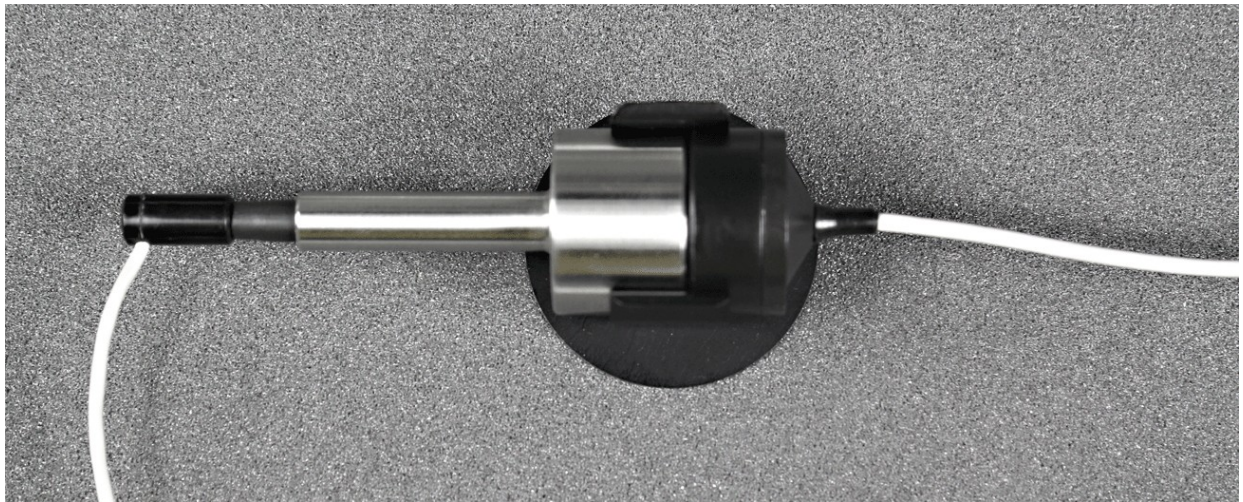

3. When prompted, select the coupling (foam tip or mold) that will be used for the on-ear RECD measurement.
4. If a valid RECD transducer calibration exists, go to RECD on-ear response.
5. If no calibration exists or the measurement interval has been exceeded, connect the BTE coupler to the coupler microphone and connect the RECD transducer to the BTE coupler.
6. Highlight and <PICK> [Calibrate RECD transducer] and follow the setup instructions.
7. Press <Continue> to generate the coupler response curve (green). When this curve is stable, press

<Continue> to save it.

8. Highlight and <PICK> [Daily] or [Weekly] to toggle the measurement interval for the coupler response.

## Measure RECD

Connect the RECD transducer to the RECD jack on the front of the test chamber.

Prepare the system for on-ear tests. See [Calibration of on-ear probe microphone](#).

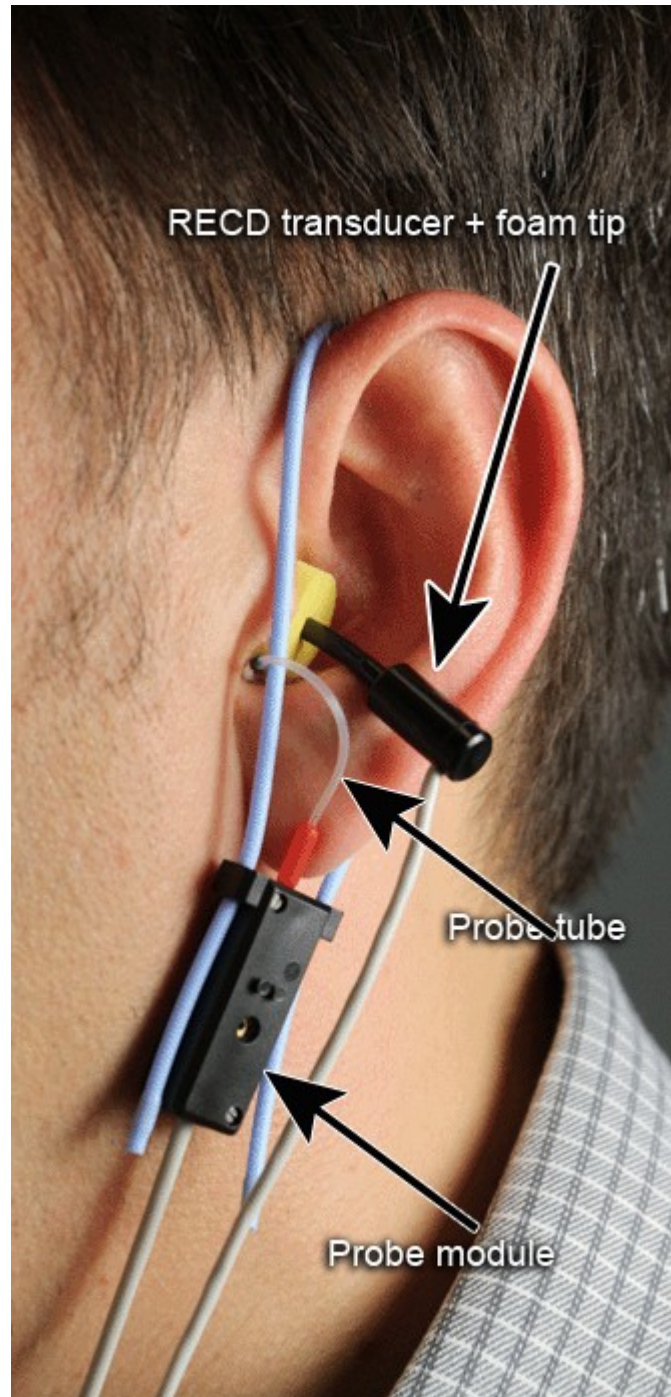

1. Press <Tests> then highlight and <PICK> [On-ear measures], then highlight and <PICK> [RECD].
2. Select the RECD coupling method that will be used on the ear. Audioscan software supports both foam eartips and personal earmold, however this choice must be made prior to measurement.
3. If no RECD calibration exists or the measurement interval has been exceeded, go to 15.3: Calibration of RECD coupler. If a valid transducer calibration exists, highlight and <PICK> [Measure real ear].

4. Refer to Positioning the probe tube and insert the probe tube into the ear canal to within 2 - 5 mm of the eardrum.
5. Insert the foam tip into the ear, being careful not to advance the probe tube further into the ear canal. Foam tip insertion depth should be as used with insert phones. Allow the foam tip to fully expand in the ear.
6. Press <Continue> to generate the real-ear response curve (pink) and the RECD curve (cyan). If the RECD curve is negative and unstable in the low frequencies, check the seal of the foam tip. Increase the tip size and/or apply a lubricant to the foam tip to improve the seal. If the RECD curve deviates more than 10 dB from the average in the 4 - 6 kHz region, check for proper probe placement and possible blockage of the tube by the foam tip or cerumen.
7. When these curves are stable, press <Continue> to save them.

For comparison purposes, the DSL 5.0 age-related average RECD is shown as a dotted curve on the screen. If you have accessed RECD from the on-ear tests list, you may highlight and <PICK> the Age box to change the age for this reference curve.

## RECD results

The RECD measurement screen shows the transducer calibration in the in the 2cc coupler (1) and the response measured in the real ear (2). The difference between these curves is the RECD (3). The DSL5.0 age-appropriate average RECD is shown for reference (4).

A negative RECD below about 1 kHz, often indicates a poor seal between the foam tip and the ear canal, or an unsealed vent in an earmold. A negative RECD above 1 kHz often indicates a blocked or pinched probe tube. See RECD facts, Calibration of RECD transducer, Measure RECD, RECD Protocols.

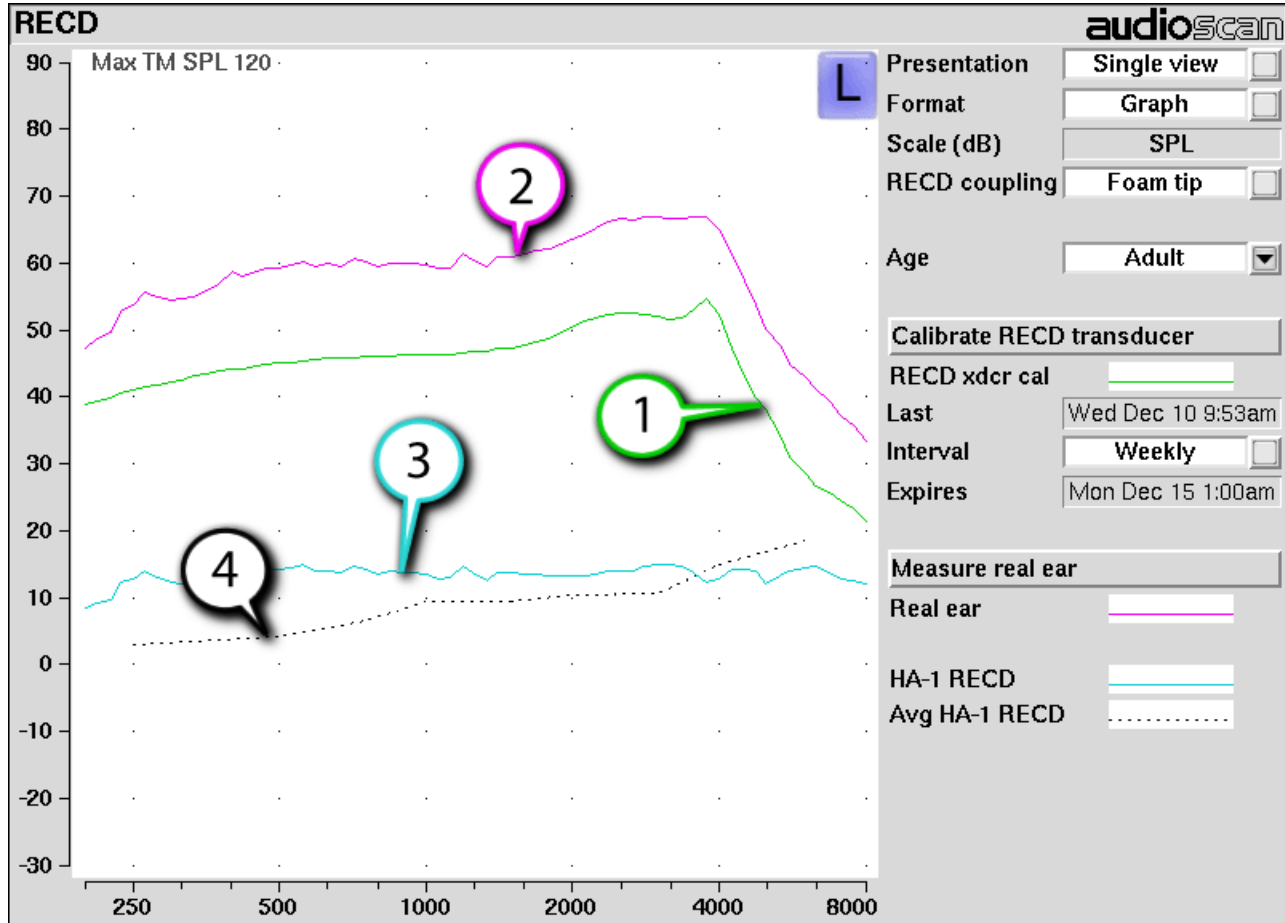

## ANSI S3.46(2013) RECD

The ANSI S3.46(2013) Real Ear standard advises RECD measurement protocols that make the RECD a property of the ear itself, and independent of transducer or acoustic coupling. To achieve this accuracy certain conditions must be met in both RECD measurement and Test-box Speechmap coupling.

As earmold tubing effects are dependent on coupled sound source, the ANSI protocol accounts for these by making the earmold part of the Speechmap testing in the test box. BTE hearing aids are coupled to the HA-1 coupler through the client's personal earmold.

For similar reasons, the on-ear RECD measurement is performed with a foam eartip, rather than the earmold. This minimizes the error that arises from unknown lengths of tubing added to the RECD transducer. These tubing effects are now more correctly being accounted for during the simulation on the coupler.

The ANSI RECD protocol can pose certain challenges in clinical implementation so alternate methods of RECD measurement are possible. Test-box Speechmap allows the selection of coupling for BTE instruments (HA-1 or HA-2) so the more traditional HA-2 (BTE) coupler can be utilized.

## RECD protocols

A measured RECD is used both for simulation in the coupler (Test-box Speechmap) and for correcting HL thresholds measured with insert phones.

For threshold corrections in the HL-to-SPL transform, the Verifit uses an HA-1 RECD or an HA-2 RECD including tubing effects, based on whether the stated HL transducer is Insert+foam or Insert+mold respectively. If the RECD was measured with an earmold, these tubing effects will be specific to the client's earmold; if it is measured with a foam tip, they will be based on average earmold tubing.

For Test box Speechmap involving BTE instruments the earmold tubing must be considered. If the BTE is coupled to the HA-1 coupler using the personal earmold, the tubing effects will be part of the measurement. If the HA-2 (BTE) coupler is used, the HA-1 referenced RECD will be converted to an HA-2 RECD. As with the threshold correction above, the use of the earmold in RECD will include the effects specific to the client's earmold, otherwise an average earmold is assumed.

The following describes acceptable RECD measurement protocols and Test-box Speechmap coupling combinations for BTE instruments and the implications of each in the test box simulation.

**ANSI S3.46 method:**

*RECD On-ear measurement:* Audioscan RECD transducer + foam eartip

*Test-box Speechmap coupling:* client's personal earmold + HA-1 (ITE) coupler

With this method, RECD is a property of the ear only, and not dependent on the transducer or sound source coupling. The earmold effects will be part of the measurement in the test box. Measured RECD is appropriate for coupler simulation and HL threshold correction, and error is minimized.

**Alternate method #1:**

*RECD On-ear measurement:* Audioscan RECD transducer + client's personal earmold

*Test-box Speechmap coupling:* HA-2 (BTE) coupler

This method utilizes the client's personal earmold for the on-ear RECD measurement. The HA-1 RECD is converted to HA-2 reference with earmold effects retained and is applied in Testbox Speechmap. The error introduced is the difference between the earmold effects when connected to the hearing instrument receiver and earmold effects when connected to the RECD transducer.

If the total earmold tubing length is less than 35mm, it is recommended that Foam tip be selected in the RECD Coupling field. This will bypass the correction and increase accuracy for small earmolds.

**Alternate method #2:**

*RECD On-ear measurement:* Audioscan RECD transducer + foam eartip

*Test-box Speechmap coupling:* HA-2 (BTE) coupler

Since the RECD here is measured with a foam eartip, an average earmold is added to obtain an HA-2 RECD with earmold effects. The error involved will be the difference between the actual earmold and the average used.

**Alternate method #3:**

*RECD On-ear measurement:* Audioscan RECD transducer + client's personal earmold

*Test-box Speechmap coupling:* client's personal earmold + HA-1 (ITE) coupler

An average earmold will be subtracted from the measured RECD to obtain an HA-1 RECD without earmold effects. The actual earmold will be introduced during test box simulation, but error will exist equal to the

difference between the earmold measured on the RECD transducer and the average earmold that was subtracted

## RECD facts

Individual RECD values are derived by comparing the SPL produced by a sound source in the closed ear canal to that produced by the same sound source in a 2cc coupler. It is commonly assumed that the RECD so measured is a property of the individual ear and is independent of the sound source used to obtain it, making it useful for (1) converting HL threshold and UCL obtained using insert phones to SPL values, (2) simulating real ear measurements from 2cc coupler measures (test box); and (3) deriving 2cc coupler targets from real-ear aided targets. However, this assumption is true, only if the acoustic impedance of the sound source is significantly higher than the acoustic impedance of the ear canal or the coupler. This is the case for RIC, ITE, and ITC hearing aids and is approximately true for insert earphones with the supplied foam tips. The acoustic impedance of insert earphones drops if the foam tip is replaced by an earmold or the tubing that forms part of the HA-2 coupler. At some frequencies, for BTE hearing aids with their earhooks and earmold tubing (or the HA-2 coupler tubing), the acoustic impedance approaches that of an adult ear and falls below that of a child's ear. Each of these sound sources will produce a different RECD and, if the acoustic impedance of the sound source differs for the ear canal and 2cc coupler measurements, further RECD differences will result.

Audioscan uses the HA-2 (BTE) coupler for the transducer calibration, then our RECD transducer and either a foam eartip or the client's personal earmold for the real ear measurement. When a foam tip is used, we subtract the two measurements to get an HA-1 RECD. When an earmold is used on the ear measurement we first subtract an average earmold (referenced to our RECD transducer) to obtain an HA-1 RECD, then we add the same average earmold (referenced to an ER3A) to obtain an HA-2 RECD with earmold effects retained.

When the entered HL transducer is Insert + foam, we apply an HA-1 foam tip RECD during the HL-to-SPL transform to correct the thresholds measured in a non-average ear canal. When the HL transducer is Insert + Mold we apply the HA-2 referenced RECD with earmold effects retained to the HL-to-SPL transform.

In Test-box Speechmap (simulated REM) we apply the HA-1 RECD to the coupler measurement for ITE, ITC, CIC, RIC instruments, and also to BTE instruments when BTE + mold has been selected (and personal earmold used in the measurement). When the instrument type is set to BTE (HA-2) the HA-2 referenced RECD is applied.

RECD values are stored, displayed, and printed referenced to the HA-1 coupler. Imported data from software versions 3.10.39 and earlier will be HA-2 referenced and will be converted to HA-1 referenced data for use, storage, and display. Subsequent printing, saving, or export will show the converted HA-1 referenced values only.

If you use insert ear phones for audiometry OR if you verify using the test box, you should measure RECD (preferred) or use age-related average RECD.



## 17 Insertion Gain

Insertion gain is the difference between aided and unaided ear canal SPL (REIG = REAG - REUG). It inherently assumes a sound-field audiogram. For non-linear hearing aids, REIG is stimulus-dependent and the dependency is specific to each hearing aid. Insertion gain fitting methods ignore these facts. **Speechmap is recommended for fitting all linear and non-linear hearing instruments.**

Refer to [On-Ear Measures - Setup](#) and [On-Ear Measures Screen Setup](#) for terminology and information on preparing the system for use and for proper positioning of the client and the probe tube.

### Insertion gain in SPL

1. Press <Tests>, then highlight and <PICK> [On-ear measures], then highlight and <PICK> [Insertion gain].
2. Highlight and <PICK> [Instrument] to chose from BTE, ITE, ITC, CIC, Body. This changes the CORFIG used for 2cc targets.
3. Highlight and <PICK> fitting method to chose from FIG6, NAL-NL1, NAL-R, POGO II, Berger, Libby, User, None

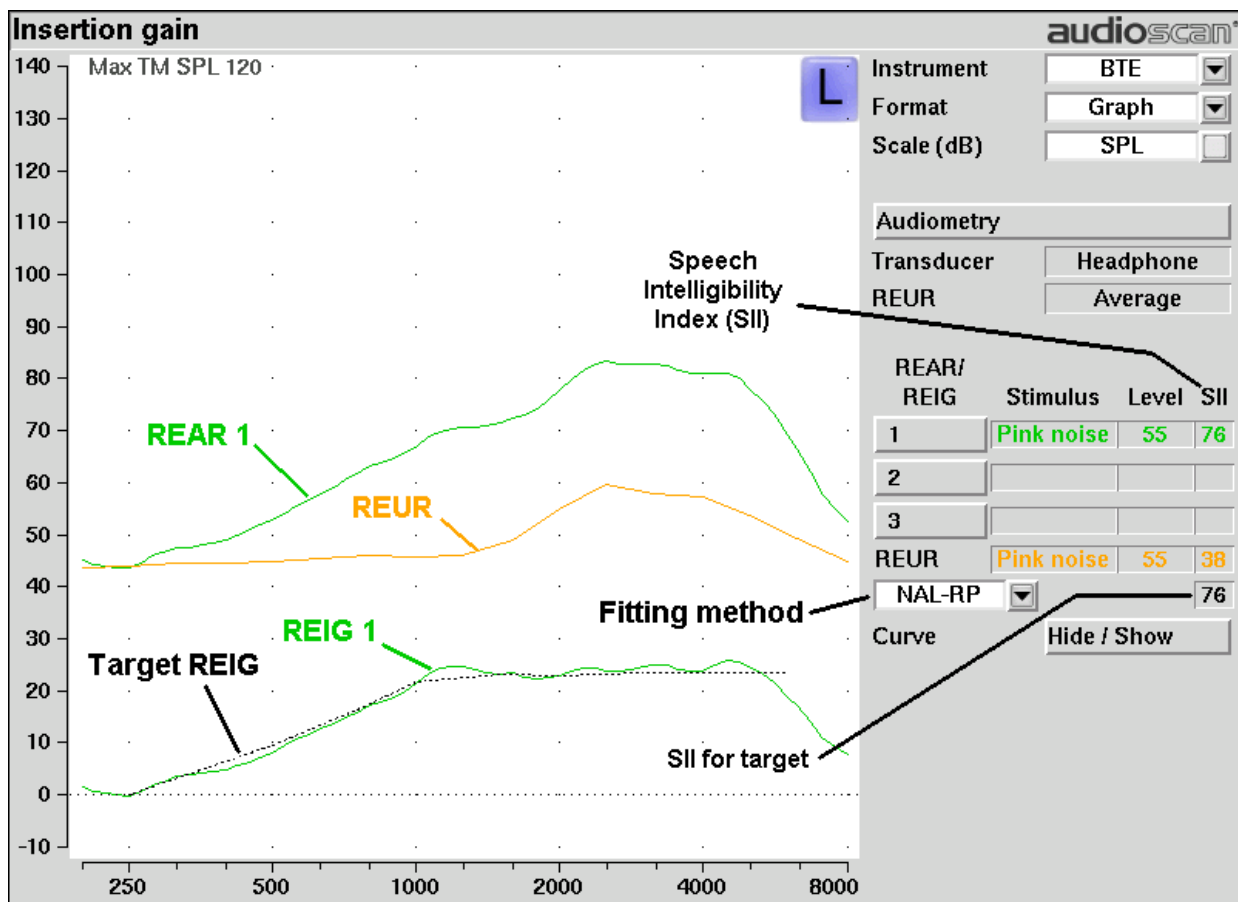

## Insertion gain in HL

Refer to On-Ear Measures - Setup and On-Ear Measures Screen Setup for terminology and information on preparing the system for use and for proper positioning of the client and the probe tube

1. Press <Tests>, then highlight and <PICK> [On-ear measures], then highlight and <PICK> [Insertion gain]
2. Highlight and <PICK> [Instrument] to chose from BTE, ITE, ITC, CIC, Body. This changes the CORFIG used for 2cc targets.
3. Highlight and <PICK> the fitting method button to chose from FIG6, NAL-NL1, NAL-RP, POGO II, BERGER, LIBBY, USER, NONE.

An estimated aided threshold curve is calculated by shifting the unaided threshold curve upward by the REIG. This estimate assumes a) the *unaided threshold is a sound-field threshold* and b) a *linear aid* (i.e. REIG doesn't depend on level).

The REUR curve uses the right-hand SPL scale and is shown for reference only.

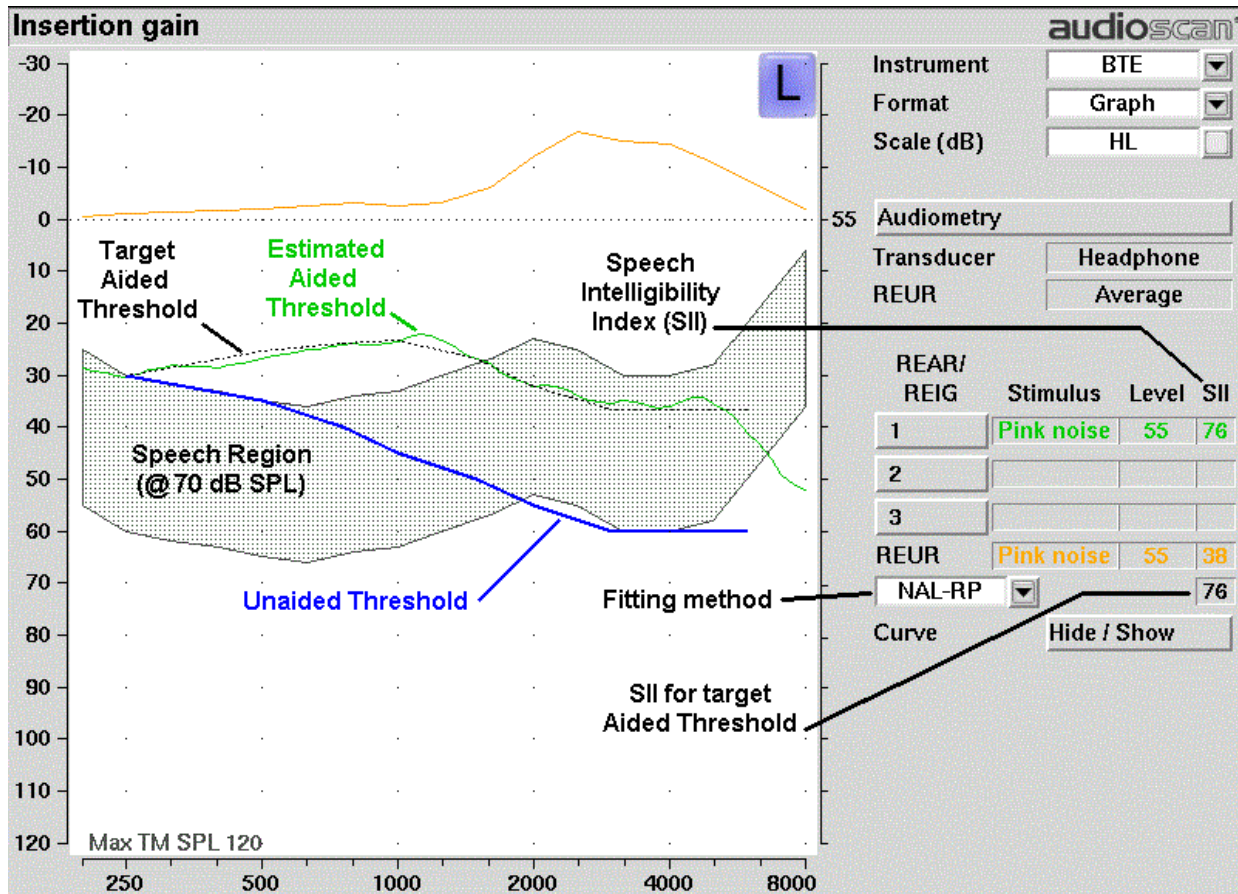

## Audiometric data entry

Threshold data and parameters may be entered by scanning a barcode on a previous Audioscan printout or

manually using a mouse, the keypad or the numeric keypad on an external keyboard. See [Mouse, keyboard, barcode scanner](#) and [Input device operation](#).

**To enter data from a barcode** see [Barcode data input](#) and:

1. Press the barcode trigger and center the red line on the barcode from a distance of 6 – 8 in. (15 – 20 cm). The scanner will beep and the Barcode entry poster opens.
2. Highlight and <PICK> [Done] to accept the data indicated on the poster.

**To enter assessment data and parameters manually:**

1. Highlight and <PICK> [Audiometry].

2. Highlight and <PICK> [Transducer], then highlight and <PICK> from the list.
3. Highlight and <PICK> [REUR], then highlight and <PICK> to toggle selection.

*Measured REUR should be used with a soundfield threshold because individual REUR is part of the threshold. Average REUR should be used with headphone or insert phone thresholds because individual REUR isn't part of these thresholds.*

4. When all selections have been completed, press <Continue>.
5. Enter HL threshold values using a mouse or keypad. Left click the mouse on the audiogram form to enter a point. Click again to delete the point. On the keypad use the arrow keys to change frequency and level and press <PICK> to enter or delete a threshold point.
6. Press <Continue> when all points have been entered.

The HL for the highest frequency is used for aided targets at higher frequencies.

## REUR measurement procedure

Performing a REUR test erases all existing REAR and REIG data associated with the current test ear. REUR should be measured only if Transducer = Soundfield. Otherwise it is more accurate to use average. See [Audiometric data entry](#).

1. Press <Tests>, then highlight and <PICK> [On-ear measures], then highlight and <PICK> [Insertion gain].
2. Referring to [On-Ear Measures - Setup](#) and [On-Ear Measures Screen Setup](#), prepare the system, position the patient and insert the probe tube.
3. If REUR is set to Average, highlight and <PICK> [Audiometry] then highlight and <PICK> [REUR] to toggle to [Measure]. Press <Continue> to advance to the Threshold entry poster. You may enter threshold

data at this time (see Audiometric data entry) or press <Continue> to proceed with the measurement.

4. Highlight and <PICK> REUR (below REAR/REIG test 3).
5. Press <Continue> to accept the default 55 dB SPL Pink noise stimulus and capture the REUR curve OR highlight and <PICK> [Stimulus] and [Level] to select other values. These choices have no impact on the resulting REIG.
6. If there is a notch in the 4000 to 8000 Hz region, try advancing the probe tube 2 mm and repeating step 3. If the notch moves to a higher frequency, repeat this step until the notch moves beyond the highest frequency of interest.

Because it is analyzed in 1/3 octave bands, the Noise stimulus produces a REUR 12 dB below that produced by the Swept stimulus at the same overall level.

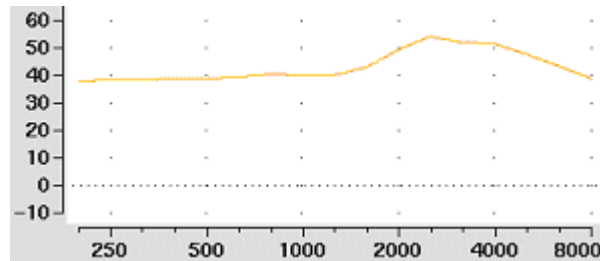

The Average REUR used is shown above. Measured REUR will vary from this.

For small children the peak may shift to the right and become sharper. Drainage tubes and perforated ear drums will cause large differences - usually around 1 kHz.

## REAR measurement procedure

1. Press <Tests>, then highlight and <PICK> [On-ear measures], then highlight and <PICK> [Insertion gain].
2. Referring to [On-Ear Measures - Setup](#) and [On-Ear Measures Screen Setup](#), prepare the system, position the patient and insert the probe tube. (For tight-fitting hearing aids or earmolds, the probe tube may be inserted through a vent.)
3. Without disturbing the probe tube, insert the hearing instrument or earmold.
4. Referring to Audiometric data entry, enter threshold data.
5. Highlight and <PICK> button 1, 2, or 3 in the REAR/REIG column. This will present a signal from the sound-field speaker and display the REAR Setup box.
6. Highlight and <PICK> [Stimulus], then highlight and <PICK> [Pink noise] or [Swept]. Use pink noise when using the NAL-NL1 fitting formula. Use Swept when testing maximum output capabilities.
7. Highlight and <PICK> [Level], then highlight and <PICK> a stimulus level from the list box. Use the level shown on the target REIG curves (if present). If no level is shown, use the lowest level required to overcome background noise.
8. Adjust the hearing instrument so that the REIG curve (SPL scale) or Aided threshold curve (HL scale) approximates the dotted target curve. For multi-level targets, match each curve using the stimulus level indicated.
9. Press <Continue> to complete the test and capture the data.

See [Insertion gain in SPL](#) and [Insertion gain in HL](#) for an explanation of screen curves. See [SII calculation in](#)

Insertion gain

**NOTE:** Because it is analyzed in 1/3 octave bands, the Noise stimulus produces a REAR up to 12 dB below that produced by the Swept stimulus at the same overall level. The REIGs will be similar except at levels which cause non-linear operation of the hearing instrument.

## SII calculation in Insertion gain

The RM500SL calculates a Speech Intelligibility Index (SII) value for unaided speech at 70 dB SPL (REUR), the target REIG and for each aided test. The calculations use the 1/3 octave band method of ANSI S3.5 –1997 without the 160 Hz band and without masking effects with results expressed as a % by multiplying by 100. Level distortion effects are included but no hearing loss desensitization is applied. An idealized speech region of LTASS +/- 15 dB is used.

The speech recognition associated with a given SII is a function of the test material and the cognitive abilities of the listener. There is considerable individual variability in relating the SII to speech recognition, especially amongst impaired listeners. The following shows expected nominal recognition scores vs SII for normals when using a variety of speech stimulus conditions. (Killion and Mueller, Hearing Journal, January, 2010 pp 10-15).

SII (%)	% Cor. Digits	% Cor. IEEE Sentences	% Cor. NU6 Words
0	0	0	0
5	30	4	4
10	80	9	8
15	96	13	11
20	98	19	19
25	99	43	27
30	100	60	36
35	100	74	45
40	100	89	56
45	100	94	63
50	100	96	70
55	100	98	76
60	100	99	81
70	100	99	87
80	100	100	93
90	100	100	96

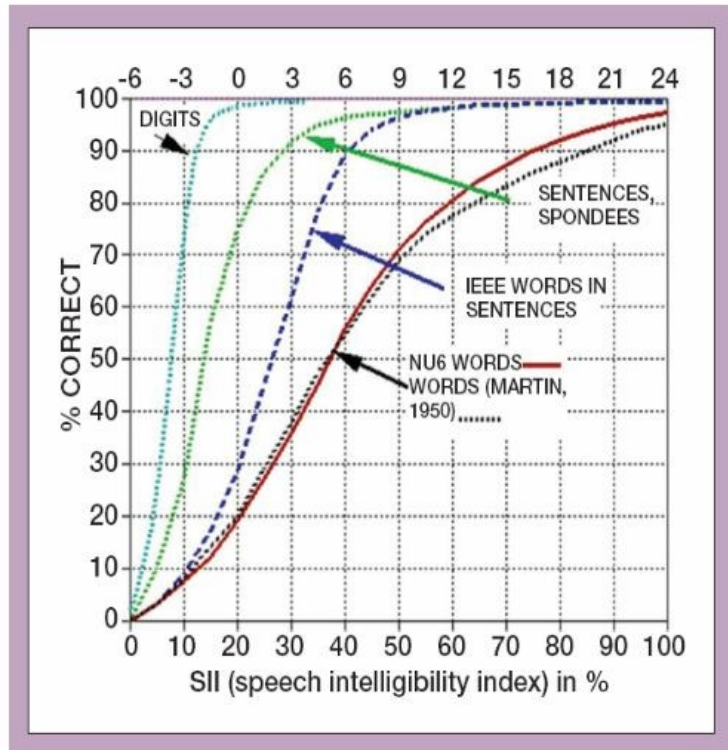

## 18 Speechmap

Speechmap presents hearing threshold, UCL and amplified speech spectra as SPL in the ear canal. The fitting goal is to make amplified speech audible and comfortable while avoiding discomfort for loud sounds.

Speechmap may be accessed from the Tests menu as either a Test box measure or an On-ear measure. See On-ear or Test box mode for details.

Speechmap is normally used in SPL and this guide describes only this usage. See SPL or HL scale for details.

### Speechmap facts

*Speechmap* is a trademarked hearing instrument fitting environment introduced by Audioscan in 1992. It presents hearing threshold, UCL and amplified speech spectra as SPL in the ear canal. The fitting goal is to make amplified speech audible and comfortable while avoiding discomfort for loud sounds. Originally speech was simulated using amplitude-modulated tonal signals. The RM500SL replaces these simulated speech signals with real speech, both recorded and live. For details of the test signals and analysis methods, see [Speechmap Technical Details](#).

Speechmap departs from insertion gain target methods in presenting amplification goals in the context of the residual auditory area, not as an isolated target line, and in the use of real speech, not tones or broad-band noise. This is extremely important for non-linear hearing aids, analog or digital, because their processing is signal-dependent. It also makes provision to correct audiometric data and 2cc coupler measurements for age-related or individually-measured acoustic differences between real ears and the couplers used for calibration and testing.

The Speechmap environment provides two hearing instrument verification options: *on-ear measures* and *test box measures*. See [On-ear or Test box mode](#) for details.

### DSL 5.0 in Speechmap



The *Desired Sensation Level (DSL)* method is a systematic eardrum sound pressure level (SPLogram) approach to hearing instrument fitting that seeks to ensure amplified speech will be audible and comfortable while loud sounds will not be uncomfortable. It takes into account individual acoustic factors in audiometric and electroacoustic data. DSL was developed by the National Centre for Audiology (NCA), London, Ontario. Audioscan has implemented DSL within its Speechmap fitting system since 1994.

In 2005, DSL underwent an extensive revision resulting in DSL 5.0. It was further revised in 2007 to version 5.0a. See [DSL 5.0 changes](#) for details of the changes.

The Audioscan version of DSL 5.0 may differ from others in the following ways:

1. DSL 5.0 uses RECD values for ages > 119 months from a different source than for ages up to and including 119 months; Audioscan has used the RECD values for a 119 month old for ages > 119 months so all values come from the same study.
2. Input-output curve targets and compression threshold targets are not provided. Such steady-state parameters are of little value in estimating amplified speech levels. Matching amplified speech to the LTASS targets at levels from 50 to 75 dB SPL provides much better assurance that fitting goals are being met.

3. There is no provision to input the number of compression channels. This may be useful when the signal used for verification is not the signal for which the targets were developed. It is irrelevant when using real-speech signals to match speech targets and when using narrow-band signals to match narrow-band maximum output targets.
4. The term Uncomfortable Level (UCL) is used rather than Upper Limit of Comfort (ULC) in referring to the ear canal SPL that should never be exceeded.
5. Broadband output limiting targets are not provided.

## DSL 5.0 changes

The Audioscan version of DSL 5.0 includes provision for *bone conduction* and *ABR* threshold, *binaural* targets, targets for speech levels from *50 to 75 dB SPL*, *new targets* for children, *targets for adults* and *new RECD* default values for children (1 month to 10 years) and adults. The *UWO child's spectrum* has been removed and an *'own voice'* spectrum has been added. As a result of a re-analysis of published data, the *vocal effort effects* for *Soft and Average speech* levels have been made the same. In addition, the target symbol has been elongated to indicate that the fit-to *target is a range, not a point*.

The children's *LTASSa* targets for 70 dB speech are lower than those in previous versions of DSL. These differences are functions of the hearing loss and age (where average RECDs are used). Revisions made in version 5.0a reduce these differences at 250 Hz and for more severe losses. The differences will be more significant when the individual RECD values have not been measured for the child being fitted.

Audioscan assumes no responsibility for the validity of these changes; that responsibility rests with the National Centre for Audiology.

## NAL-NL1 in Speechmap

The *NAL-NL1* procedure seeks to amplify speech such that all bands of speech are perceived with equal loudness while maximizing speech intelligibility and ensuring that the wearer perceives speech to be no louder than that which a normal hearing person would perceive. Although *NAL-NL1* states its goals for speech, it derives insertion gain targets assuming noise as a verification signal. Because it is more accurate to verify a non-linear fitting using the signal for which the procedure was developed, Audioscan converts the *NAL-NL1* insertion gain targets to *LTASS* targets for amplified speech in the *Speechmap* environment, resulting in *Speechmap/NAL-NL1*. The conversions use the same adult average RECD and REUG as used in DSL. The RESR targets are from *Hearing Aids* (Dillon, Thieme Publishing, 2001, p274).

An insertion gain version is available by selecting [Insertion gain] from the on-ear measures test menu. The pink noise stimulus should be used.

## NAL-NL2 in Speechmap

Fitting targets, default age-related RECD and REUG are provided by a software library used under license from Hearworks Pty Ltd. which is solely responsible for their derivation.

This revision of *NAL-NL1* has many more input parameters and output target formats than its predecessor. In implementing *NAL-NL2*, Audioscan has made the following simplifications and clarifications:

1. *NAL-NL2* targets are provided as REAR targets in *Speechmap*. Insertion Gain targets are not provided.
2. There is no provision to select Insert earphones + earmold as the audiometric transducer since this invalidates the audiometer calibration and correction for this error is problematic.
3. Input-output curve targets and compression threshold targets are not provided. Such steady-state parameters

- are of little value in estimating amplified speech levels. Matching amplified speech to the LTASS targets at levels from 50 to 75 dB SPL provides much better assurance that fitting goals are being met.
4. There is no requirement to input client gender. The impact of gender on REAR targets is less than +/- 1dB.
  5. There is no requirement to input hearing aid experience. An "Experienced" user is assumed. The reduction in NAL-NL2 REAR targets for an inexperienced user is less than 4.5 dB.
  6. There is no provision to generate targets for tonal languages. The REAR targets for tonal language differ less than 2.5 dB from those for non-tonal languages.
  7. There is no requirement to input the number of compression channels. This may be useful when the signal used for verification is not the signal for which the targets were developed. It is irrelevant when using real-speech signals to match speech targets and when using narrow-band signals to match narrow-band maximum output targets.
  8. There is no requirement to input compression speed. It has no impact on REAR targets.
  9. There is no requirement to input earmold tubing type. It has no impact on REAR targets.
  10. There is no requirement to input vent size or fitting depth. They have no impact on REAR targets.
  11. For sound-field threshold the speaker is assumed to be at 45 degrees. For on-ear measurements, the speaker is assumed to be at 0 degrees and the reference microphone is assumed to be on the head surface.
  12. The SII calculation is per ANSI S3.5-1997 and is the same for all fitting methods.

## Camfit in Speechmap

Camfit is an approach to fitting hearing aids developed by Brian Moore at the University of Cambridge, UK. It specifies the level-dependent gain required to correct abnormal loudness as modelled by his cochlear hearing loss simulation. It provides two approaches to correcting for the hearing loss:

*Camfit restoration* aims to amplify sounds that are soft, comfortable and loud for a person with normal hearing so that they are soft, comfortable and loud for a hearing aid wearer. This is the stated goal of the IHAFF (International Hearing Aid Fitting Forum) fitting method.

*Camfit equalisation* aims to amplify speech to produce the same loudness in each critical band. It has been argued that this is likely to give the highest intelligibility for a given overall loudness. This is the rationale behind the NAL fitting methods and will generally produce similar targets.

## Using Speechmap

The Speechmap fitting environment provides a number of distinctly different stimuli. Speech and noise are analyzed in 1/3 octave bands and for most speech stimuli data are presented as 3 curves. The top curve is the level exceeded 1% of the time (speech peaks), the lower curve is the level exceeded 70% of the time (speech valleys) and the middle curve is the average. Starting a test causes the signal to be presented continuously - the speech signals run in a loop - and the curves are updated frequently to show any changes you make to the hearing instrument. Pressing <Continue> restarts the speech passage and the curves are then calculated for the entire passage, producing an accurate display of the speech region and LTASS, and an accurate SII calculation. When using live speech, a <Freeze curve> button captures short-term speech features. See SII calculation in Speechmap and Speechmap Technical Details.

Before starting, please see On-Ear Measures - Setup, Speechmap Setup, Speechmap facts, On-ear or Test box mode.



- **To access Speechmap:** press <Tests>, then highlight and <PICK> [On-ear measures] or [Test box measures], then highlight and <PICK> [Speechmap].
- **To change screen setup:** see On-Ear Measures Screen Setup, and On-ear or Test box mode.
- **To set up hearing instrument type:** highlight & <PICK> [Instrument], then highlight & <PICK> BTE, ITE, ITC, CIC, RITE (receiver in the ear – test box mode), Open (On-ear mode), Body, CROS (On-ear mode) or FM. This changes microphone location effects and the RECD used in test box measures and 2cc targets, and the reference microphone used for FM and CROS. In the case of a CIC a deep insertion factor is applied to the estimated ear canal SPL.
- **To enter audiometric data:** see Assessment data entry.

To run a test, highlight and <PICK> one of the 4 Test buttons. Then highlight and <PICK> [Stimulus] to select the stimulus type. Highlight and <PICK> [Level] to select stimulus level. Press <Continue> to run the test and display the data. See, Screen tour & Speechmap Fitting Procedures.

## Speechmap Setup

Speechmap provides a number of different test stimuli for fitting hearing aids and testing various aspects of their performance. Each time you run a test, you have the opportunity to select the stimulus from a list. You can manage which stimuli appear on this list by doing the following:

Press <Setup>, then highlight and <PICK> Speechmap.

Setup Speechmap	
Hide speech envelopes	automatically <input type="checkbox"/>
Choose Speechmap stimuli:	
MPO <input checked="" type="checkbox"/>	Speech-female <input type="checkbox"/>
Speech-std(1) <input checked="" type="checkbox"/>	Speech-child <input type="checkbox"/>
Speech-std(2) <input type="checkbox"/>	Speech-live <input type="checkbox"/>
Speech-ISTS <input checked="" type="checkbox"/>	Speech3150 <input type="checkbox"/>
	Speech4000 <input checked="" type="checkbox"/>
	Speech5000 <input type="checkbox"/>
	Speech6300 <input checked="" type="checkbox"/>
	ICRA noise <input type="checkbox"/>
	Pink noise <input checked="" type="checkbox"/>

The available Speechmap stimuli are in two columns. The left-hand column contains the MPO stimulus and speech stimuli that have the specific Long-Term Average Speech Spectrum (LTASS) required when matching prescription fitting targets such as DSL, NAL-NL1 or NAL-NL2. The MPO stimulus (used to verify that the maximum output SPL of the hearing aid does not exceed the uncomfortable level) is always selected. You must select at least one of the defined LTASS speech stimuli.

1. To select a stimulus, highlight and <PICK> the stimulus you want to add to the list. A check mark will be placed next to the selected stimulus.

2. To remove a checked stimulus from the list, highlight and <PICK> the stimulus you want to remove.

You can also choose to have the envelopes of the speech test results automatically hidden (leaving only the LTASS) when you start another test. Highlight and <PICK> the Hide speech envelopes button to toggle between automatically and manually.

When you have finished making your selections, press <Continue> to exit Setup.

## Screen tour - unaided screen

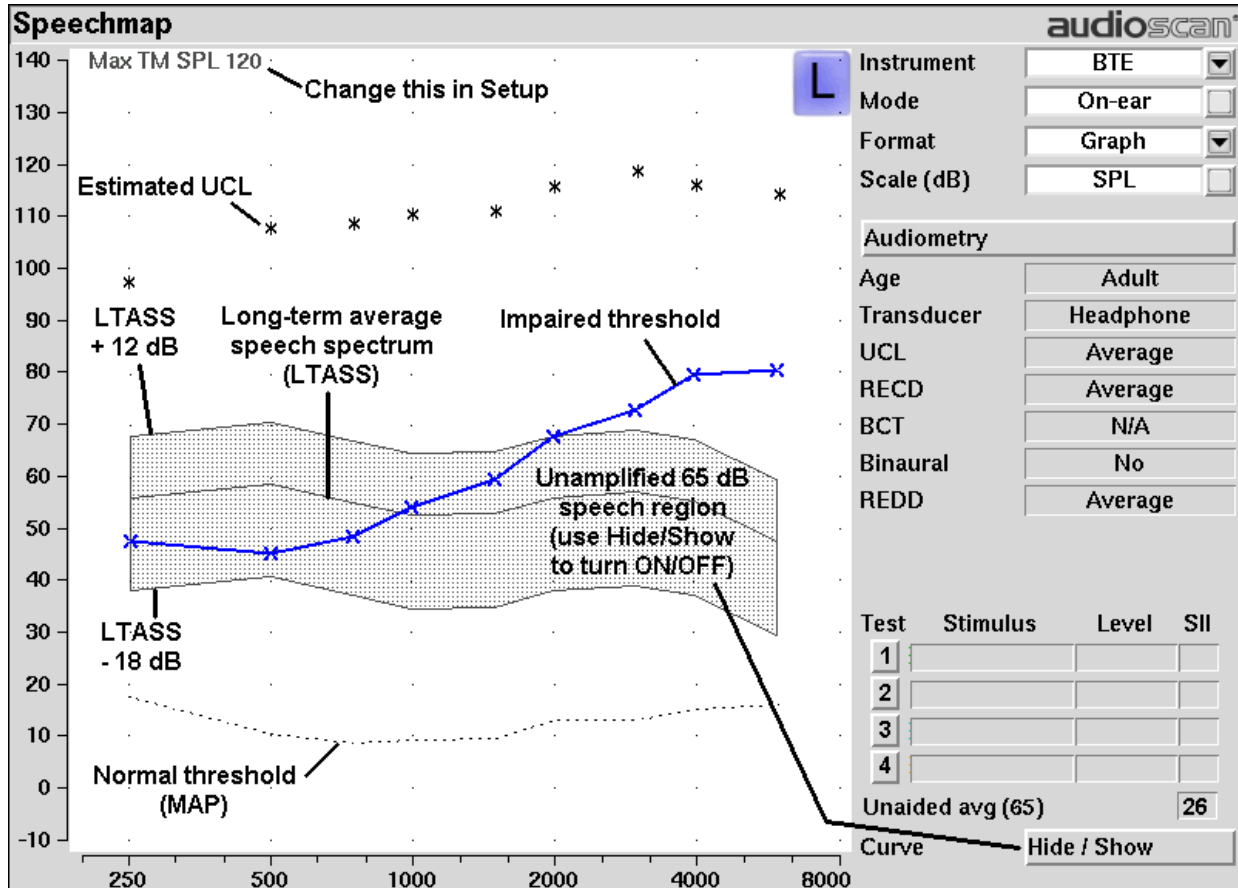

## Screen tour - aided screen

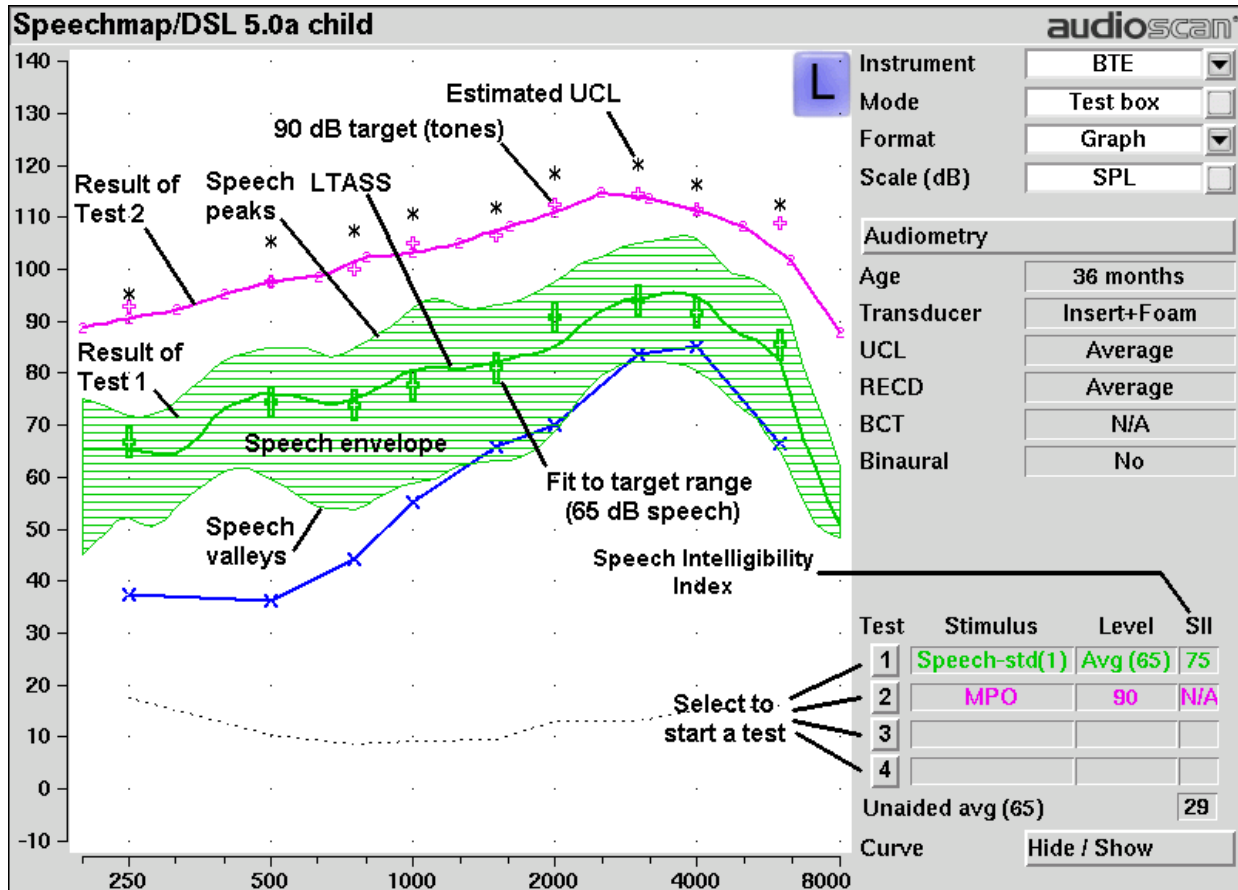

## On-ear or Test box mode

The Speechmap environment provides two hearing instrument verification options: *On-ear measures* and *Test box measures*. Using on-ear mode, the stimulus is controlled by the on-ear reference microphone below the ear and SPL in the ear canal is measured by the probe microphone. In test box mode, levels measured in the 2cc coupler are converted to estimated ear canal levels using the RECD values (age-appropriate average, entered, or measured). In addition, the stimulus delivered to the hearing instrument microphone is modified to include average microphone location effects for the hearing instrument type indicated. The screen display for both modes is the same, showing SPL, measured or simulated, in the ear canal.

**For On-ear mode:** press <Tests>, then highlight and <PICK> On-ear measures and highlight and <PICK> Speechmap. Review On-Ear Measures - Setup,

**For Test box mode:** press <Tests>, then highlight and <PICK> Test box measures and highlight and <PICK> Speechmap. Review Calibrating test box reference microphone, Coupling the hearing instrument, Positioning the hearing instrument.

**To switch modes:** highlight and <PICK> [Mode].

It is suggested that hearing instruments be preset in test box mode with fine tuning done in on-ear mode.

*Note that on-ear mode should be used for vented or open fittings.* Vent effects depend on the vent, the ear and

the hearing aid settings and cannot be reliably predicted from 2cc coupler measurements.

## SII calculation in Speechmap

The RM500SL calculates a Speech Intelligibility Index (SII) value (in %) for unaided speech at 65 dB SPL and for each aided test. The calculations use the 1/3 octave band method of ANSI S3.5 –1997 without the 160 Hz band and without masking effects with results expressed as a % by multiplying by 100. Level distortion effects are included but no hearing loss desensitization is applied. An idealized speech region of LTASS +/- 15 dB is used.

The speech recognition associated with a given SII is a function of the test material and the cognitive abilities of the listener. There is considerable individual variability in relating the SII to speech recognition, especially amongst impaired listeners. The following shows expected nominal recognition scores vs SII for normals when using a variety of speech stimulus conditions. (Killion and Mueller, Hearing Journal, January, 2010 pp 10-15).

SII (%)	% Cor. Digits	% Cor. IEEE Sentences	% Cor. NU6 Words
0	0	0	0
5	30	4	4
10	80	9	8
15	96	13	11
20	98	19	19
25	99	43	27
30	100	60	36
35	100	74	45
40	100	89	56
45	100	94	63
50	100	96	70
55	100	98	76
60	100	99	81
70	100	99	87
80	100	100	93
90	100	100	96

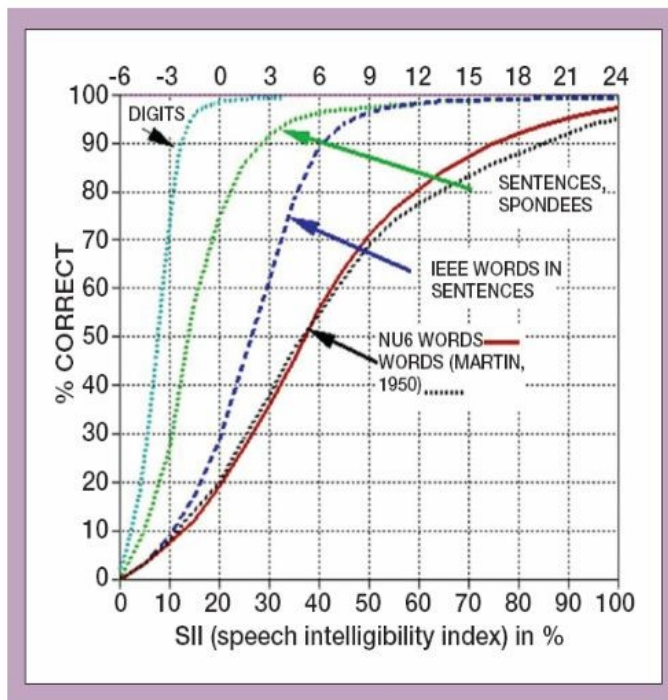

## Using custom stimuli in Speechmap

Custom digital sound files can be used as stimuli in Speechmap. If you connect a USB stick with WAV files on it to the RM500SL, Speechmap will make those files available as stimulus selections. This feature provides the freedom of using any stimulus in Speechmap with all the features that Speechmap offers. Please note that fitting targets are not available for custom stimuli.

A USB stick is required for this feature. It is highly recommended that the USB stick is formatted for data using the Audioscan Updater prior to using this feature. The Audioscan Updater comes with any current Audioscan software download or Cd. Visit [www.audioscan.com](http://www.audioscan.com) to obtain software updates.

### To use digital sound files as stimuli in Speechmap:

1. Connect a USB stick to your PC.

2. Format the USB stick for data using the Audioscan Updater.
3. Create digital sound files that are compatible with Speechmap (see [Creating WAV files for Speechmap](#)).
4. Copy the WAV files from the PC to the top level directory (i.e. not in any folder) of the USB stick.
5. Disconnect the USB stick from the PC and connect it to the USB port on the RM500SL.
6. Start a Test in Speechmap (see [Using Speechmap](#)).
7. <PICK> [Stimulus]. Compatible WAV files will appear as selectable options in the stimulus list below the default stimuli. You may need to scroll down to see all the stimuli.
8. <PICK> your custom stimulus. After a short delay, your stimulus will begin playing.
9. Use your new stimulus with all the features of Speechmap.

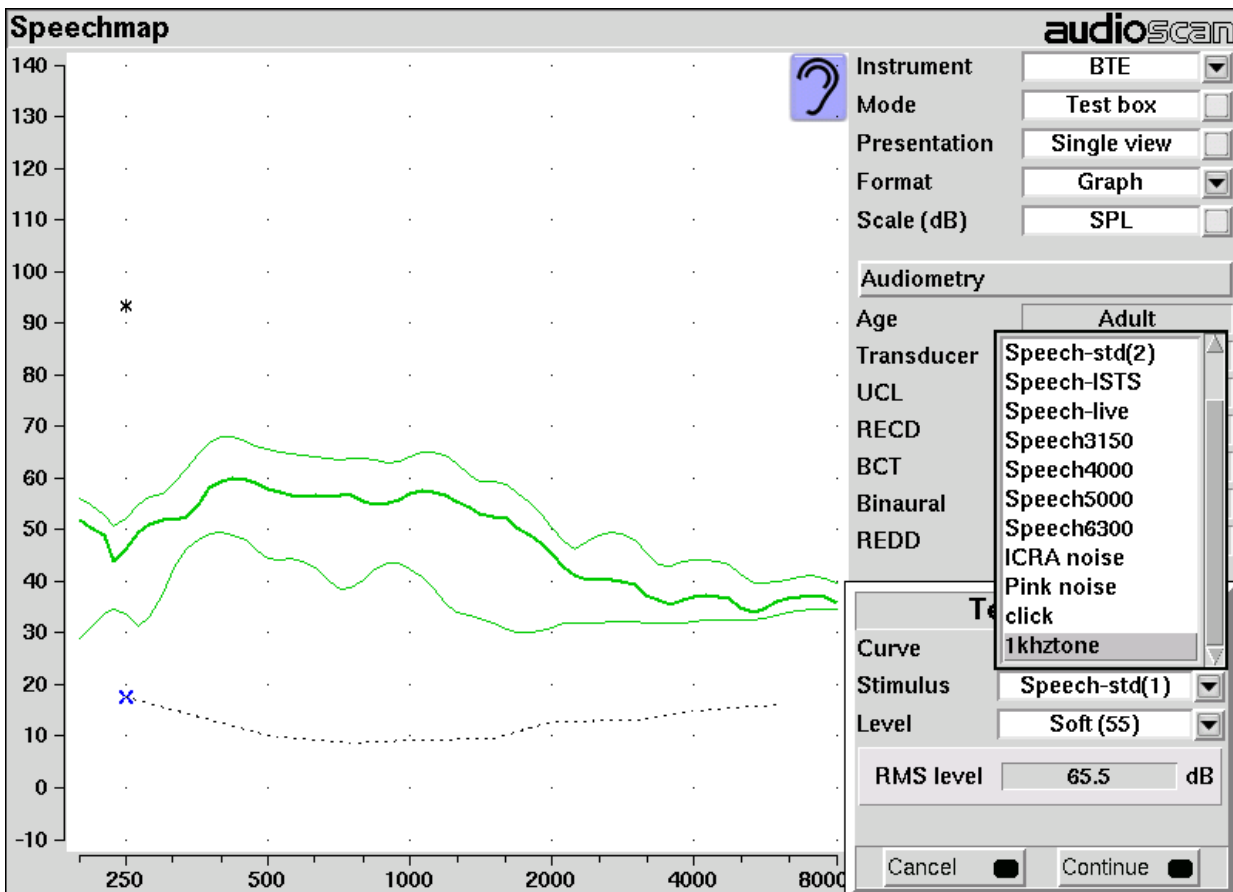

Example of two custom files, “click.wav” and “1khztone.wav”, in the stimulus list.

**To remove custom stimuli from Speechmap:** close any Test prompts and disconnect the USB stick from the RM500SL.

**Notes:**

- Files that are greater than 20 seconds in duration will be truncated to 20 seconds.
- Speechmap will show up to 10 compatible WAV files. If you have more than 10, we recommend that you use multiple USB sticks or organize your files into folders, moving them into the top level directory of the USB stick as needed.

- Removing the USB stick while a Test post is open may cause unexpected behavior. Close the Test post before removing the USB stick from the RM500SL.

## Creating WAV files for Speechmap

WAV is a commonly used format for digital audio and can be created/edited by nearly all audio editing and recording software. A WAV file has many properties that define the format of the digital audio. When a USB stick is connected to the RM500SL, Speechmap looks for files in the top level directory that have the following properties:

**File format:** WAV

**Data format:** PCM (no compression)

**Sampling Rate:** 32 kHz

**Bit precision:** 16 or 32 bit

**Channels:** Mono

**File name:** 15 characters or less, not including .wav extension

Existing WAV files can easily be converted to match these specifications using your preferred audio editing software.

### Leveling Options

By default, Speechmap will automatically level the WAV file so that the Long Term Spectrum matches the level selected for the test.

The automatic leveling of the WAV file can be modified by inserting a tag in the filename. This feature allows you to fine tune the output level of your stimulus. The tag must be added at the end of the filename but before the extension.

Example: **filename\_+2.5.wav**

The tag must consist of an underscore, followed by a plus or minus sign, followed by the modifier in dB. In the example above, the tag “\_+2.5” will level the file to be 2.5 dB above nominal.

There are no restrictions on the magnitude of the modifier; there is built-in protection against speaker overdrive. Precision is limited only by the 15 character limit of the filename.

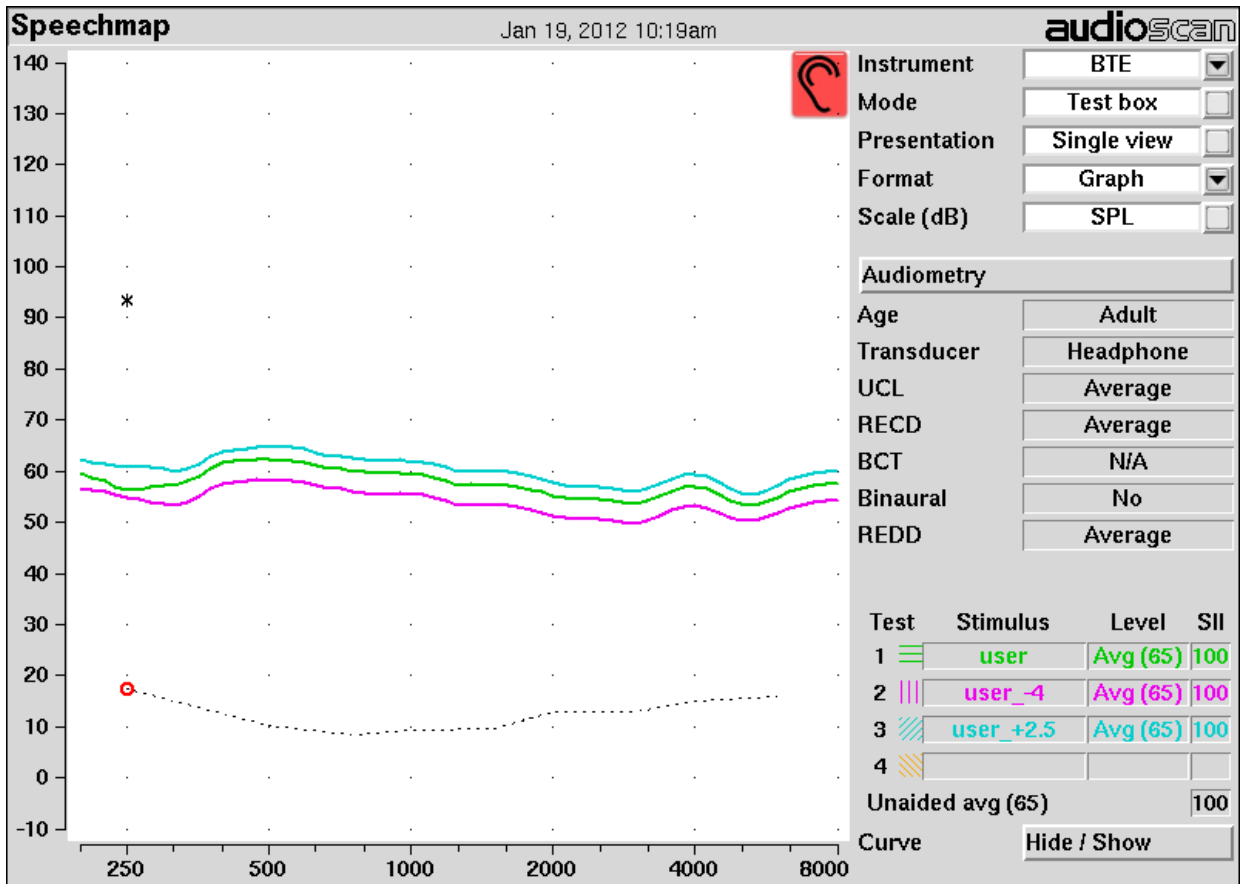

Example of user-supplied files, “user.wav”, “user\_-4.wav” and “user\_+2.5.wav”.

## 19 Speechmap Fitting Procedures

The Speechmap fitting screen provides a number of choices for inputting and applying audiometric data for the verification of hearing instrument fittings. The procedures in this section assume a familiarity with [Test Box Measures - Setup](#), [On-Ear Measures - Setup](#), [On-Ear Measures Screen Setup](#) and [Speechmap](#).

### Assessment data entry

Threshold data and parameters may be entered by scanning a barcode on a previous Audioscan printout or manually using a mouse, the keypad or the numeric keypad on an external keyboard. See [Mouse, keyboard, barcode scanner, and Input device operation](#).

**To enter data from a barcode see Barcode data input and:**

1. Press the barcode trigger and center the red line on the barcode from a distance of 6 – 8 in.(15 – 20 cm). The scanner will beep and the Barcode Entry poster opens.
2. Highlight and <PICK> [Done] to accept the data indicated on the poster.

**To enter assessment data manually:**

1. Highlight and <PICK> [Audiometry].
2. Highlight and <PICK> an item to toggle its setting or generate a list box. Age can be changed only if Targets = [DSL child]. See [Assessment data choices - 1](#) and [Assessment data choices – 2](#)
3. Press <Continue> to proceed to data entry.
4. Enter HL threshold using a mouse, keypad or keyboard. Left click the mouse on the audiogram to enter a point. Click again to delete the point. On the keypad the arrow keys change frequency and level and <PICK> enters or deletes a threshold point. On a keyboard enter HL values on the numeric keypad.
5. Press <Continue> when all points have been entered.
6. Repeat the process for Bone conduction, UCL and RECD if [Enter] has been selected for any. If RECD is set to [Measure], see RECD (real-ear to coupler difference).



Audiometry	
Ear	Right
Targets	DSL adult
Age	Adult
Transducer	Insert+Foam
Threshold	Entered
Bone conduction	N/A <input type="checkbox"/>
UCL	Average <input type="checkbox"/>
RECD	Average
Binaural	No <input type="checkbox"/>
<input type="button" value="Cancel"/> <input type="button" value="Continue"/> <input type="button" value="Help"/>	

## Assessment data choices

The following audiometric assessment parameters can be specified in the Speechmap Audiometry setup box. Defaults are the last-used choices if test setup memory has been turned on. See [Saving test setup](#).

1. **Target:** Select fitting targets from [DSL adult, DSL child, NAL-NL1, [NAL-NL2 Camfit restoration](#), [Camfit equalization](#), None]. See [DSL 5.0 in Speechmap](#), [NAL-NL1 in Speechmap](#), [NAL-NL2 in Speechmap](#), [Camfit in Speechmap](#).
2. **Age:** This is permitted for [DSL child] and [NAL-NL2] targets only. Select client's age in months from [1 months to 60 months] or years from [6 years to 10 years]. For children older than 10 yrs, previously fit using DSL, choose Adult.
3. **HL transducer:** Type of audiogram. Select from [Headphone, Insert + Foam or Soundfield]. In addition, if Target= DSL, you may chose from [Insert + Mold, ABR (eHL), ABR (nHL)]. If *Insert + Foam or Mold* is selected, the appropriate RECD will be used to convert entered HL values to SPL values. If *Soundfield* is selected appropriate real-ear unaided gain (REUG) values @ 45 degrees azimuth, will be used to convert HL values to SPL values. If *ABR (eHL)* is selected, entered thresholds will be treated as behavioral pure tone thresholds. If *ABR (nHL)* is selected, nHL to eHL conversion factors may be selected from [Default, Enter]. In either case, an insert earphone is assumed for sound delivery and the appropriate RECD will be applied. Note that, in some facilities, nHL is defined in such a way that it is effectively eHL; in these cases, ABR (eHL) should be selected. See [ABR nHL to eHL setup](#) and [Assessment data choices – 2](#).
4. **Bone conduction:** Select from [N/A, Enter]. If [Enter] is selected, an entry screen will be provided after the air conduction thresholds have been entered.
5. **UCL:** Uncomfortable Level. Select from [Enter, Average]. If measured UCL values are entered, these values will be converted to real-ear SPL and used as real-ear saturation response (RESR) targets. Note that DSL 5.0 has changed this term to Upper Limit of Comfort (ULC). Regardless of the acronym, it is a narrow-band SPL that should never be exceeded.
6. **RECD:** Select from [DSL Average, Enter, Measure] if the target rule is DSL child or adult, [NL2 Average,

Enter, Measure] if the target rule is NAL-NL2 or [Average, Enter, Measure] otherwise. The RECD is used to convert entered HL data (thresholds and UCL's) to SPL values on the Speechmap screen (when Insert+Foam or Insert+Mold is selected as HL Transducer) and to convert coupler SPL measured in the test box to estimated ear canal SPL. The DSL child and NAL-NL2 fitting rules provide differing age-appropriate average RECDs which will result in differing SPL thresholds. Estimated ear canal SPL always uses DSL data when RECD set to average. If Measure is selected, you will be required to measure the client's RECD values or accept values from the RECD test. If Enter is selected, HA-2 or HA-1 RECD values may be entered and are required *at all 9 audiometric frequencies*. When Enter or Measure is selected, you will be required to specify the coupling in use between the RECD transducer and ear.

7. **RECD Coupling:** Select from [Earmold, Foam tip]. Specifies the coupling between the RECD transducer and ear. A correction will be applied when entering HA-2 referenced RECD data and when measuring with earmold.
8. **Binaural:** Select from [Yes, No]. Determines if fitting targets will be adjusted for binaural summation effects. This is excluded for [DSL child] targets.
9. **REDD:** Real-ear-to-Dial Difference. [Average] (this cannot be changed). REDD values are similar for adults and children. If Headphone is selected as the transducer type, adult average values will be used to transform dB HL audiometry to dB SPL.
10. **ABR nHL to eHL:** Normalized HL to estimated HL conversion factors. Permitted only if [Transducer] = ABR (nHL). Select from [Default, Enter]. If [Enter] is selected, an entry screen will be provided after threshold data have been entered. Otherwise default factors will be used. These may be set to DSL values or to values that you have entered in Setup. Note that, in some facilities, nHL is defined in such a way that it is effectively eHL; in these cases, ABR (eHL) should be selected and no conversion factors will be applied. See [ABR nHL to eHL setup](#).

## Fitting to targets for soft speech

See [On-ear or Test box mode](#), [Using Speechmap](#) and [Assessment data entry](#) for setup and audiometric data entry.

1. Select [Audiometry] to choose the target method and enter audiometric data.
2. Select Test 1 and set stimulus to [Speech ISTS], [Speech-std(1)] or [Speech-std(2)] and level to 50. Elongated + symbols show the target range for 50 dB speech LTASS.
3. Adjust frequency shaping and gain for soft sounds so that the middle curve (the LTASS) falls within the target range, especially between 500 - 4000 Hz. Press <Continue> to run the complete passage. Repeat as necessary.

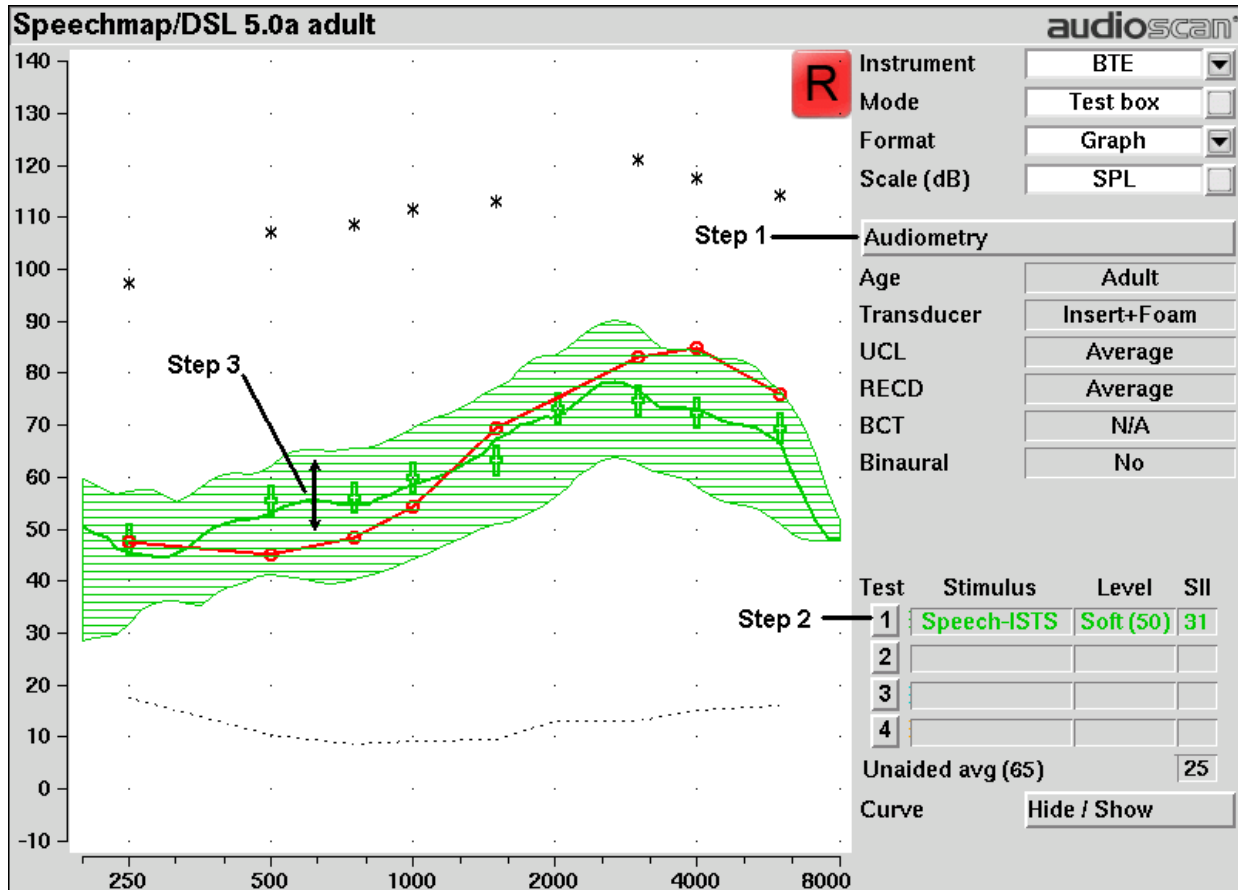

## Fitting to targets for loud sounds

4. Select Test 2 & set stimulus to [MPO]. In test box mode, 90 dB tone bursts are presented at 1/3 octave frequencies in a repeating sequence. In on-ear mode, a single sequence of 85 dB tone bursts is presented when you press <Continue>.
5. In test box mode, adjust high-level gain and/or output limiting (e.g., MPO, PC) so the curve matches the + REAR90 targets (DSL) or approaches but doesn't exceed the RESR targets (NAL-NL1, NAL-NL2) at all frequencies. Press <Continue> to record the MPO curve. In on-ear mode, advise the client to point to the screen if a sound becomes too loud during the test (see Max TM SPL setup). Press <Continue> to run and record a single sweep. Adjust the gain and output for loud sounds as for test box measures, factoring in client response. Repeat as necessary.

*Running a new test may automatically hide the speech envelope of the previous test, depending on the option chosen in Setup (see [Speechmap - Speechmap Setup](#)). To redisplay, highlight and <PICK> Hide/Show, then highlight and <PICK> the envelope display (right column) button for the test.*

## Fitting to targets for mid-level speech

6. Select Test 3 and set stimulus to [Speech-ISTS], [Speech-std(1)] or [Speech-std(2)] and level to 70. Elongated + symbols show the target range for 70 dB speech LTASS.
7. Adjust gain for mid-level sounds so that the middle curve (the LTASS) falls within the target range. Press

<Continue> to run the complete passage. Repeat as necessary. Achieving this goal may require adjusting gain for soft speech, which will reduce its audibility. This may be a necessary compromise with some hearing instruments and for clients with a very narrow dynamic range.

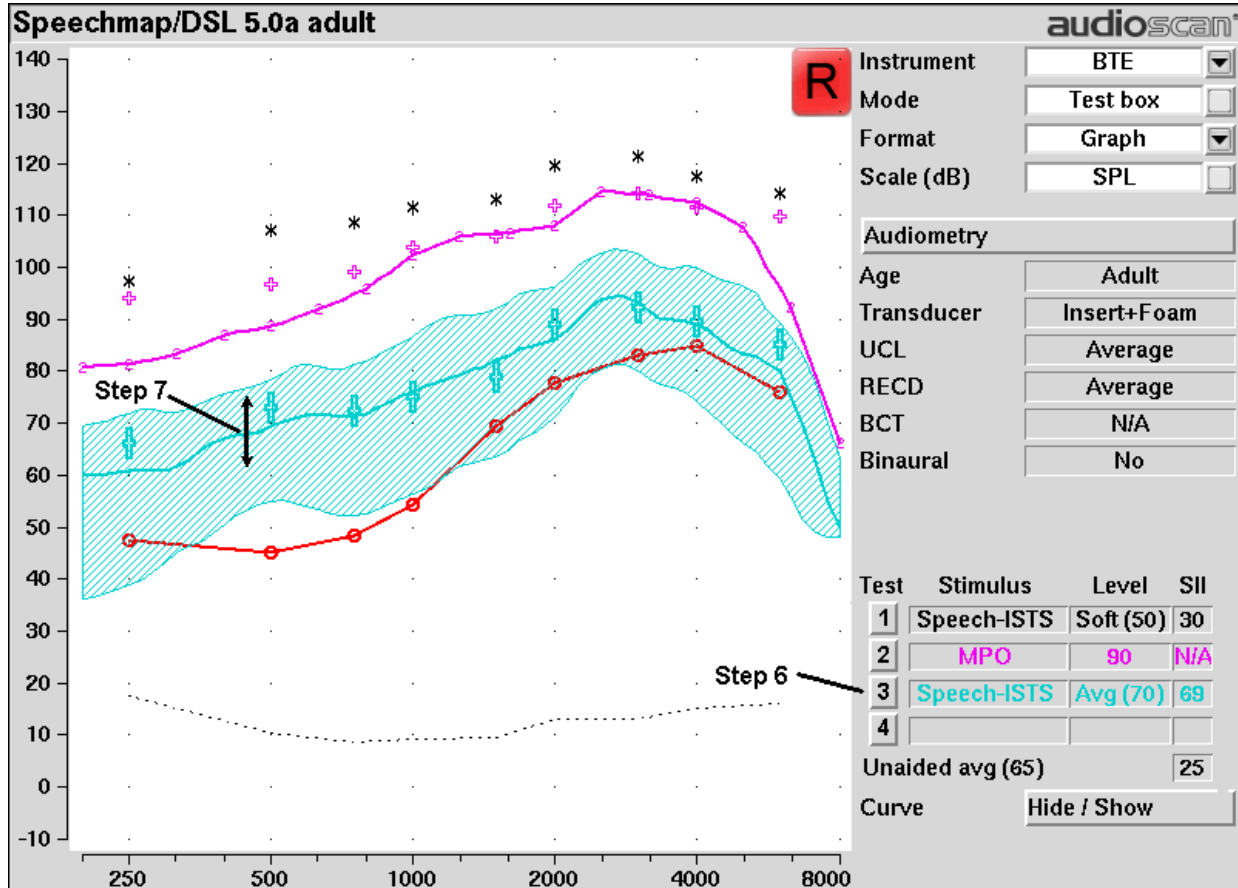

## Open fittings in Speechmap

*On-ear* mode should be used for open and vented fittings. There are no special real-ear SPL targets for open fittings - it doesn't matter how the sound reaches the TM, the perception is the same. However, the sound that escapes from a vent or open fitting may be detected by the on-ear reference microphone, interfering with the sound-field equalization. For this reason, the hearing instrument must be muted during sound-field equalization.

1. Position the client and probe tube and enter audiometric data. See [On-Ear Measures - Setup, Speechmap, Speechmap Fitting Procedures](#).
2. Highlight and <PICK> Instrument and select Open from the list.
3. Highlight and <PICK> Test 1 - 4. If this is the first Open test in a session, you will be prompted to mute or turn off the hearing instrument and select the Equalize button on the setup poster. Otherwise, you are reminded to equalize whenever the client or nearby objects are moved. After equalization, unmute or turn the instrument on and follow the fitting procedures in [Fitting to targets for soft speech](#) to [Fitting to targets for mid-level speech](#).

## Verifying Frequency Compression/ Frequency-Lowering Hearing Instruments in Speechmap

Frequency lowering is used when it is not possible to amplify the high frequency components of speech sufficiently to raise them above threshold. In this case, the high frequency components may be shifted to a lower frequency with a better hearing threshold where the available gain will render them audible.

Four modified versions of the Speech-std (1) test stimulus (Speech3150, Speech4000, Speech 5000 and Speech6300) are provided in Speechmap to assist in verifying and adjusting frequency lowering devices. In each of these modified test stimuli, the 1/3 octave band levels above 1000Hz are reduced by 30dB, except for an isolated 1/3 octave band centered at the frequency indicated in the selected test stimulus' name. With these reduced band levels, the resulting LTASS produces a distinct 'cavity' between 1000Hz and the selected high frequency band, as seen below for the FM Boom test signal. For clarity, the Speech3150 curve is not shown.

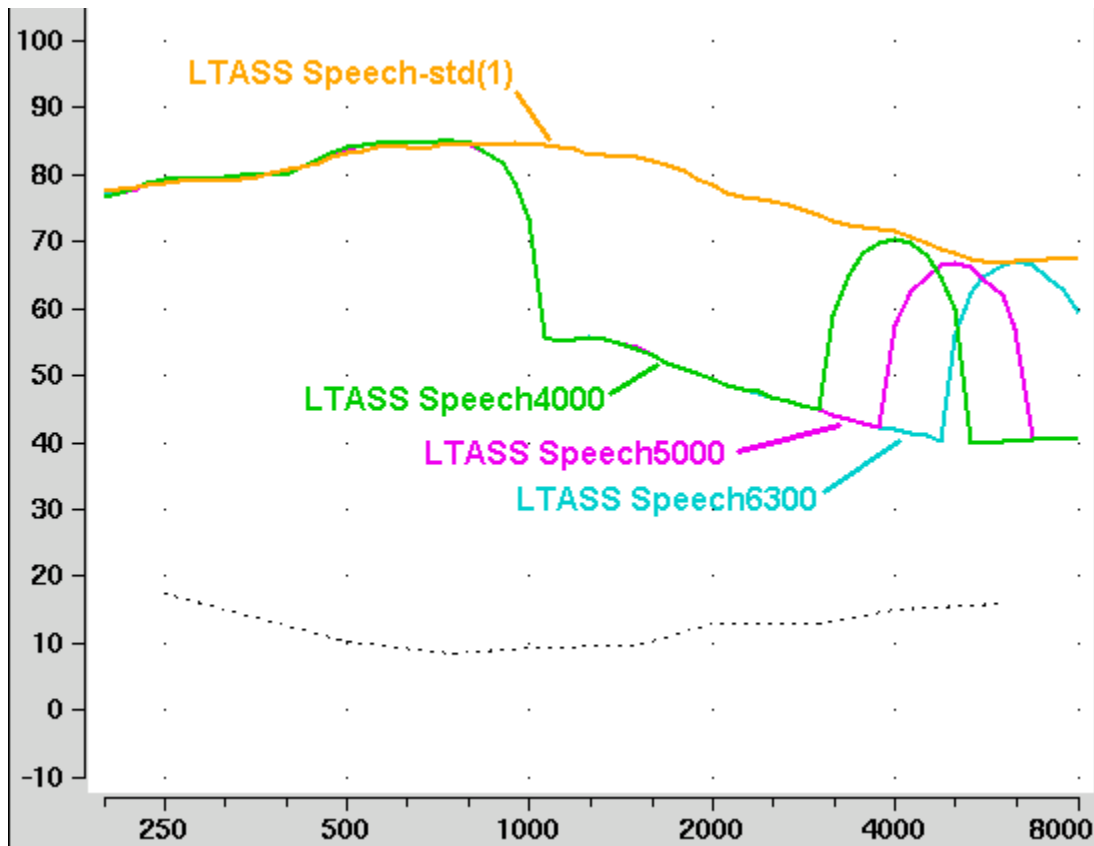

To test frequency-lowering:

1. From the Speechmap screen, choose either On-ear or Test box Mode. (Review 17.9: On-ear or Test box mode.)
2. Program the hearing instrument so that the frequency-lowering feature is inactive.
3. Select Test 1 and choose 65dB from the level menu.
4. Choose Speech3150, Speech4000, Speech5000 or Speech6300 from the stimulus menu. Note that only the LTASS is shown for these stimuli and targets (if selected) have been suppressed.
5. Press <Continue> to measure and store the long-term signal-averaged result. If the isolated band does not appear in the Test 1 curve, it may indicate that the hearing aid has no gain at the selected band frequency.

This does not mean that the hearing aid will be unable to transpose the band to a lower frequency when frequency lowering is enabled.

6. Program the hearing instrument to activate the frequency-lowering feature.
7. Select Test 2 and select the same stimulus and stimulus level used in Test 1.
8. Press <Continue> to measure and store the long-term signal-averaged result.
9. The isolated band should now appear at a lower frequency and should reach or exceed threshold at its new location as shown below. Note that the 'cavity' between 1 kHz and the isolated band may be partially or completely filled in by noise within the hearing aid which will make the isolated band appear less distinct in the test curves.
10. Once the frequency-lowering properties of the hearing instrument have been verified, use one of the Speechstd stimuli to verify aided speech audibility or target match (as described elsewhere in this section) for frequencies below the isolated band.

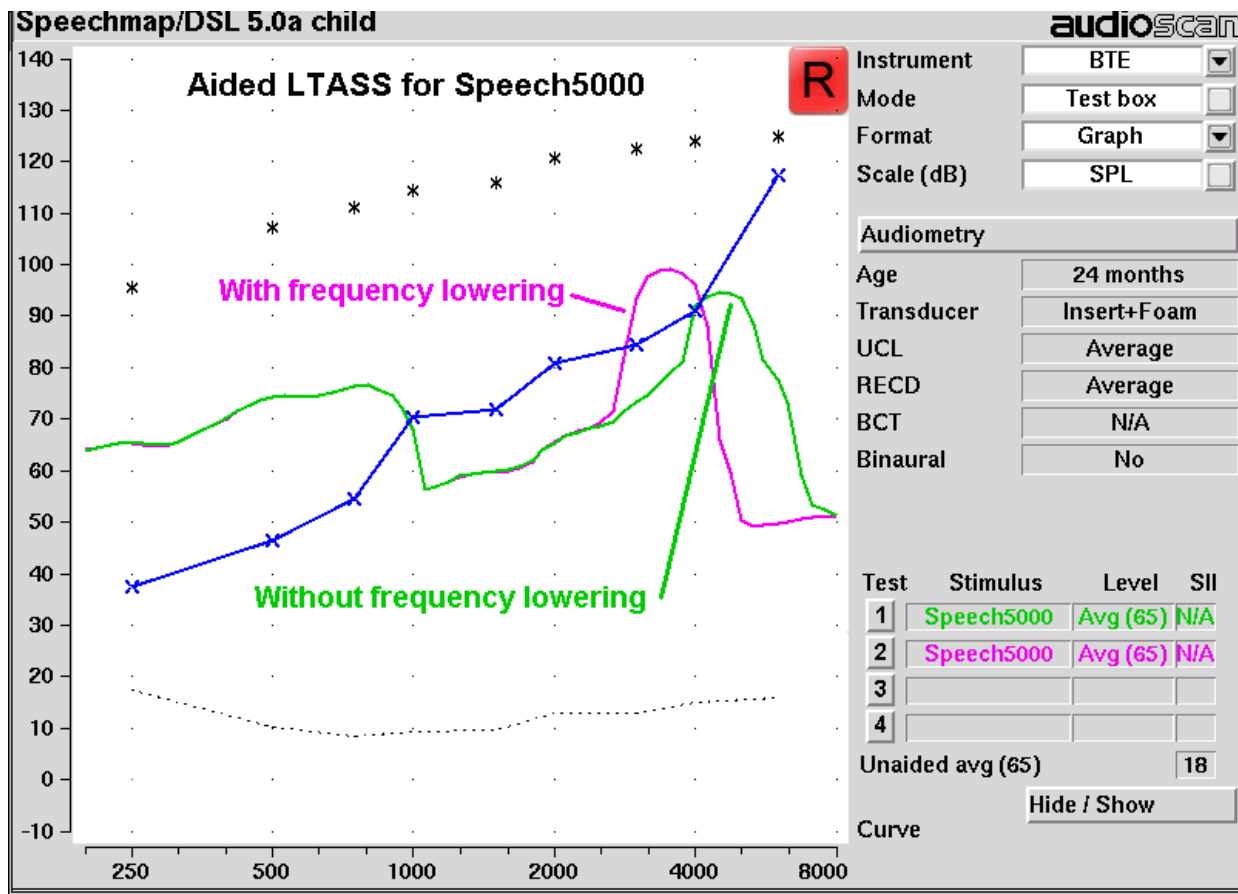

## FM fitting and verification

FM Offset or FM Transparency method in Speechmap (after Platz 2004)

It is assumed that the hearing aid has been set up for optimal audibility and maximum output. See other sections

of Speechmap Fitting Procedures.

1. Before attaching the FM receiver, couple the hearing aid to the 2cc coupler in the test box and select Speechmap from the Test box measures menu. Select the appropriate hearing Instrument type (typically BTE).
2. Highlight and <Pick> Test 1 and choose Speech-std(1), (2) or the ISTS at a Level of 65 dB. Press <Continue> to run and record the speech passage.
3. Attach the FM receiver to the hearing aid and set the FM receiver to the default setting. The FM transmitter should be ON and set to MUTE. Repeat step 2 but use Test 2 instead of Test 1. If the results of Test 1 & Test 2 are not similar, the presence of the FM receiver has changed the intended performance of the hearing aid. Where possible, make programming adjustments to compensate -being careful not to make adjustments that will change Test 1 results.
4. Move the hearing aid, attached to the coupler and microphone, outside the test box at least 12 in. (30 cm) away from the FM transmitter\*. Put FM transmitter microphone, set to Omni, within 2mm of the reference microphone in the test box.
5. With the FM transmitter unmuted, repeat step 2. Note that the hearing aid is outside the test box during this test - Quiet please! The results should be within +/- 2 dB of the results from step 3. If not, change FM settings and repeat.

\* A coupler mic. extension cable is available. See Microphone connection.

**Real-ear verification of FM-only open fittings in Speechmap** (based on AAA Clinical Practice Guidelines: Remote Microphone Hearing Assistance Technologies for Children and Youth from Birth to 21 Years. April 2008)

Open fittings must be verified in On-ear mode.

1. Enter Audiometry data and select FM from the Instrument list box.
2. Position the transmitter microphone as in step 4 above. Place the probe tube in the ear canal and couple the FM-only device to the ear canal as in normal use.
3. At maximum volume setting, select the MPO stimulus. Adjust the receiver settings to meet targets. See Fitting to targets for loud sounds.
4. At use volume setting, select Speech-std(1), (2) or the ISTS and choose FM chest (84 dB SPL) or FM boom (93 dB SPL) for the level. Adjust the FM receiver gain/volume settings to meet targets in the 1000 – 4000 Hz range.
5. Repeat step 3 at use volume setting.

## 20 Speechmap Technical Details

Speechmap provides a variety of stimuli for the testing of non-linear hearing aids with a range of digital processing features. Additional information regarding the stimuli and their analysis is provided in Appendix 2 of the printable User's Guide.

### Speechmap stimuli

The Speechmap fitting environment provides a number of well-controlled, distinctly different stimuli for both On-ear and Test box measurement modes. Four different digitized speech passages (2 male, 1 female and 1 child) are provided as well as the International Speech Test Signal (ISTS) and the single-talker International Collegium of Rehabilitative Audiology (ICRA) distorted speech signal. In addition, one of the speech passages has been filtered to provide 3 variations for evaluating frequency-lowering hearing aids. Pink noise at levels of 50 to 75 dB SPL in 5 dB steps and a tone burst at 85 or 90 dB SPL are also available.

The two 'Speech-std' signals are by the same male talker, filtered to provide the long-term average speech spectrum (LTASS) recommended by Cox & Moore (1988) for average vocal effort. This is the LTASS assumed in the Desired Sensation Level (DSL) method of hearing aid fitting. In addition, one of these passages (the Carrots passage) has been filtered to suppress the 1/3 octave bands above 1 kHz by 30 dB with the exception of a 1/3 octave band at 4 kHz (Speech4000), a band at 5kHz (Speech5000) and a band at 6.3 kHz (Speech6300). These latter three signals may be used to determine the amount of frequency shift provided by frequency-lowering hearing aids and the sensation level of the lowered components of the speech signal. The ICRA noise, female and child speech signals are presented as recorded with no spectral shaping.

The ISTS consists of 500 ms segments from recordings of 6 female talkers reading the same passage in American English, Arabic, Chinese, French, German and Spanish. These segments have been spliced together with appropriate pauses and filtered to match the average female spectrum from Byrne et al, An international comparison of long-term average speech spectra. *J. Acoust. Soc. Am.* 96 (1994), 2108-2120. The 15 second version of this signal has been provided.

Live speech may also be used.

As a result of reanalysis of published data, the previous distinction between 'soft' and 'average' vocal effort has been eliminated. Consequently, the speech, ISTS and ICRA signals are presented unfiltered for levels from 50 to 70 dB SPL. At 75 dB SPL, the spectrum is filtered to represent a 'loud' vocal effort. An 'own voice' filter is also available at the 75 dB SPL level. This is intended to produce a spectrum and level at a BTE microphone location similar to that produced by the voice of an average wearer.

A tone burst (MPO) stimulus provides 128 ms bursts with 128 ms gaps at 1/3 octaves with a level of 90 dB SPL in the test box and 85 dB SPL for on-ear mode.

In test box mode, all signals are filtered to include BTE, ITE, ITC, CIC, Body microphone location effects. The selected overall rms level is established prior to filtering.

For fitting FM systems, the stimuli may be modified to represent the level (84 dB SPL) and spectrum at a chest microphone location and the level (93 dB SPL) and spectrum at a boom microphone location. These are presented in the test box in both on-ear and test box modes.

The overall SPL, 1/3rd octave band SPL, vocal effort and microphone location effects are given in the following tables for the various broad-band signals available.

### Stimulus levels

LTASS for standard speech is from Cox & Moore (1988). Loud spectrum is from ANSI S3.5-1997. Own voice



spectrum is from Cornelisse et al (1991) adjusted to a 1 m reference.

<i>1/3 octave band SPL</i>							<i>Add to band SPL for</i>			
<i>Hz</i>	<i>Speech</i>				<i>ICRA Noise</i>	<i>Pink Noise</i>	<i>Loud</i>	<i>Own Voice</i>	<i>FM Chest</i>	<i>FM Boom</i>
	<i>Standard</i>	<i>ISTS</i>	<i>Female</i>	<i>Child</i>						
200	56.8	57.0	54.9	32.3	52.9	53	-2.2	.5	9.0	19.2
250	56.0	57.0	53.1	51.5	55.9	53	3.3	10.7	12.0	22.2
315	53.0	53.8	48.4	57.3	56.9	53	9.6	11.0	16.6	26.0
400	57.0	57.4	55.8	54.1	57.5	53	6.1	10.0	13.3	22.8
500	58.0	57.4	57.3	53.2	57.8	53	7.7	10.1	13.2	25.3
630	55.0	56.4	58.1	61.2	54.3	53	12.4	10.5	21.0	29.1
800	52.5	53.7	54.6	56.5	52.8	53	14.4	10.8	26.4	32.1
1000	51.0	50.0	52.0	52.7	50.4	53	15.0	10.5	26.4	32.7
1250	50.5	48.0	51.0	45.4	51.3	53	14.8	5.5	22.0	33.6
1600	48.0	47.4	51.1	41.1	48.5	53	15.5	4.0	22.1	33.9
2000	45.0	44.9	51.2	39.7	47.0	53	16.2	6.0	21.0	33.0
2500	44.0	42.8	49.3	35.5	44.7	53	14.8	6.0	18.2	31.9
3150	42.5	42.7	46.0	28.8	43.3	53	14.5	2.0	14.4	30.4
4000	42.0	41.0	40.0	31.2	41.1	53	13.2	-0.5	11.8	29.0
5000	40.0	40.3	36.1	30.6	39.6	53	9.2	-1.0	12.4	27.8
6300	41.5	41.3	43.5	32.6	33.5	53	4.2	0.0	11.4	26.2
8000	41.5	40.4	39.9	35.2	28.2	53	2.7	-4.0	11.0	25.8
Overall	65.0	65.0	65.0	65.0	65.0	65	75.0	75.0	84.0	93.0

## Microphone location effects

<i>Microphone Location Effects</i>						<i>Deep Insertion</i>
Add to all stimuli in test box mode						Add to Est. Canal SPL
	Hearing instrument type					
Frequency	BTE	ITE	ITC	CIC	BODY	CIC
200	0.0	0.0	0.0	0.0	3.0	1.9
250	0.3	1.0	0.9	1.3	3.0	1.9
315	0.7	1.3	1.2	1.8	3.0	2.6
400	0.2	0.8	0.8	1.2	3.0	3.3
500	-0.1	0.8	1.0	1.3	4.0	4.0
630	-1.7	-0.3	-0.2	0.2	3.0	4.6
800	-2.0	-0.6	-0.4	0.1	2.0	5.2
1000	-2.2	-1.1	-0.9	-0.4	0.0	5.8
1250	-0.3	-0.6	-0.5	0.0	0.0	6.0

1600	4.9	3.9	3.7	4.2	0.0	6.1
2000	6.1	6.9	6.9	8.1	-4.0	6.1
2500	1.8	5.1	5.5	7.4	-3.0	6.4
3150	-0.4	2.7	2.9	5.7	-2.0	6.6
4000	0.2	6.0	4.8	8.6	0.0	7.7
5000	2.6	10.4	7.9	12.7	0.0	8.1
6300	3.0	5.2	1.2	9.0	0.0	8.4
8000	3.7	-1.6	-0.4	3.5	0.0	8.4

Microphone location effects are added after the overall rms level has been set

Note: Microphone location effects remeasured 2014 on KEMAR and referenced to sub-lobe position. Software versions prior to 3.10.56 use MLE values from DSL 4.1 so slight changes in Test box Speechmap should be expected.

## Deep insertion compensation

The deep insertion of a hearing aid or ear-mold causes the ear canal SPL to be higher than would be estimated by adding RECD to the coupler SPL measured in the test box. This most commonly occurs with Completely-in-Canal (CIC) hearing aids. When this hearing aid type is selected in Speechmap Test box, a deep insertion factor is automatically added to the estimated ear canal SPL. The factor in the following table is from DSL 5.0 and has been interpolated to 1/3 octave frequencies.

## Speech signal analysis

One of the most-used measures of a speech signal is the long-term average speech spectrum (LTASS). This is a 1/3 octave spectrum averaged over a sufficiently long portion of the speech material to provide a stable curve. In practice a 10 second average meets this requirement and, for this reason, all Verifit passages are at least 10 seconds long.

The dynamic nature of speech is often characterized by the distribution of short-term levels in each 1/3 octave band. These levels are determined by calculating a spectrum for each of a series of short time periods within the passage. Historically, time periods of 120, 125 or 128 ms have been used. The Verifit uses a 128 ms time period, resulting in 100 levels (or samples) in each 1/3 octave band for a 12.8 second passage. The level in each band that is exceeded by 1% of the samples (called L1 or 99th percentile) has historically been referred to as the speech peak for that band. The curve of the 99th percentile is approximately 12 dB above the LTASS. The level in each band that is exceeded by 70% of the samples (called L70, or 30th percentile) has historically been called the valley of speech for that band. The curve of the 30th percentiles is approximately 18 dB below the LTASS. The region between these two curves is often called the speech region, speech envelope or speech 'banana'. The speech envelope, when derived in this way, has significance in terms of both speech detection and speech understanding. Generally, speech will be detectable if the 99th percentile is at or near threshold. The Speech Intelligibility Index (SII) is maximized when the entire speech envelope (idealized as a 30 dB range) is above (masked) threshold. This will not be an SII of 100% (or 1) because of loudness distortion factors, but higher SII values will not produce significantly higher scores on most test material. The speech-reception threshold (SRT) is attained when the LTASS is at threshold (approximately - depending on test material and the individual)

## 21 Troubleshooting

This section covers common problems encountered when using the RM500SL. If you require further assistance, note your model and serial number (located next to the power switch) and contact your local distributor, or Audioscan at 519-268-3313 800-265-2093 (USA only), 519-268-3256 (fax) or service@audioscan.com

**PLEASE DO NOT SHIP YOUR UNIT BACK TO THE FACTORY.** In most cases we can courier you a part that you can quickly and easily replace yourself.

### Self test failures

Any failure during power-on self test (P.O.S.T.) is indicated on-screen and further use of the instrument is denied. Try the following steps to resolve the failure:

1. To access Self test, press <Setup>, then highlight and <PICK> [Self test].
2. If you received a Max out/in or a Routing failure, remove any hearing aids from the test chamber and rerun self test.
3. Unplug all microphones (On-ear & Test box). Rerun self test. If self test passes, reconnect the microphones, one by one, running self test each time until a failure occurs. If the failure returns, display and print the test results and contact Audioscan for help.

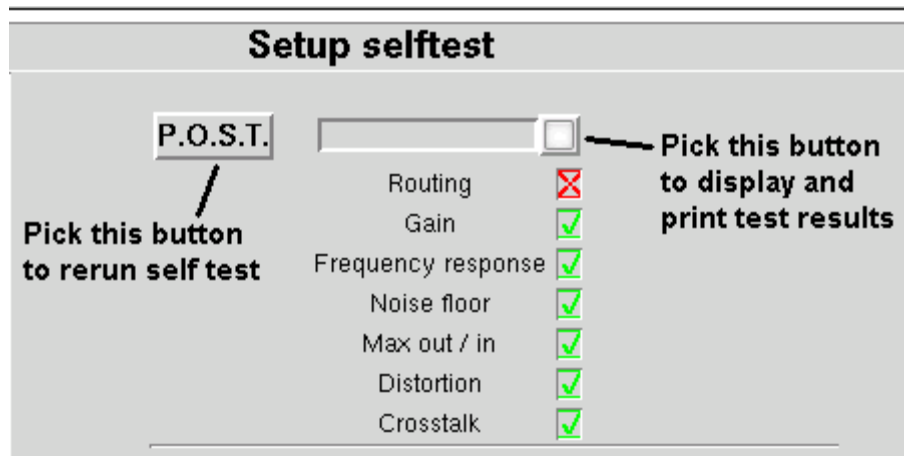

### Initialize Function

Initializing your Audioscan unit will reset it to default factory settings. This erases the user preference files stored in internal memory. Any custom printer choice, network settings, test setups will need to be re-entered and the user calibrations will also be required.

1. To initialize, press <Setup>, then highlight and <PICK> [Self test]
2. Highlight and <PICK> [Initilize]. Unit will automatically restart.

## Test box high distortion or noise

*High distortion and/or noise numbers in an ANSI test*

- There may be a leak between the hearing instrument under test and the coupler it is connected to. For BTE type instruments, check the integrity of the #13 tubing at the end of the coupler where it joins with the ear hook. Look for cracks. ITE type instruments need to have a good seal between the hearing instrument and the coupler. In addition, all vents need to be closed from the faceplate side of the hearing instrument.
- Ambient room noise may be leaking into the test chamber. Air conditioners, computer fans and similar noisemakers can yield artificially high noise figures. Check the sealing of the test chamber. Try turning off suspected noise sources to identify the cause.
- Vibration may be coupled into the test chamber from other equipment on the same table or wooden floor. Computers, fans and air conditioners may be the source of the vibration. Try turning off suspected sources to identify the cause. Relocate the source or the RM500SL on a foam pad.

## Test box curves inconsistent

*The test box curves keep changing from test to test.*

- The battery may be close to end of life or starved for air (zinc-air cells) because of a tight seal on the battery compartment. Try using a fresh battery.
- The test box reference microphone (the white one in the sound chamber) is incorrectly positioned. In order to control sound pressure levels precisely at the microphone inlet of the hearing instrument, the test box reference microphone must be positioned as close as possible to the hearing instrument's microphone without actually touching it.
- The noise or feedback reduction features are attempting to reject the test signal. These need to be disabled prior to tests with tones or noise.
- The instrument is on the verge of feedback due to a poor seal to the coupler, unplugged vent or a crack in the tubing on the BTE coupler.

## Test box curves differ from specifications

*The OSPL90 and response curves don't look like the manufacturer's.*

- Check that all controls or program settings are the same as those used by the manufacturer.
- Check that vents on earmolds or ITE instruments are plugged at the faceplate.
- Check that ITE instruments are well sealed to the coupler.
- When putting a hearing instrument into the ITE coupler, be sure to keep the canal portion of the instrument flush with the inside of the 2cc volume.
- Ensure that the test box is sealed tightly.
- Ensure that the test box microphone calibration was performed correctly.
- Check that the coupler is screwed tightly onto the coupler microphone.

## Test box speaker overdriven

*Test box speaker overdriven!*

- This message indicates that the test chamber speaker is unable to produce the SPL required for a test.
- Check that the test chamber lid is closed and sealed.
- Check that the test box calibration looks normal.
- Check that the hearing instrument under test is not feeding back.
- Try running an On-ear test.

## **No test box reference mic. detected**

*No test box reference mic. detected!*

This message may be displayed when starting a hearing instrument test. It indicates that the RM500SL is not measuring any sound at the test box reference microphone. The test box reference microphone is the white microphone located in the test chamber.

- Ensure that the test box reference microphone is secure. Unplug the white test box reference microphone. Plug the microphone back in again, ensuring that it 'clicks' into place. Try the calibration procedure again.
- Unplug the test box reference microphone and plug the on-ear probe microphone in its place. Try test box calibration using the reference microphone of the on-ear probe microphone in place of the test box reference microphone. If this is successful, the test box reference microphone is defective and must be replaced.

## **Invalid test box calibration**

*Invalid test box microphone calibration!*

This message may be displayed during the test box calibration procedure. It indicates that the calibration curve is significantly different from what is expected. It may be accompanied by a missing test box reference microphone error.

- Check that there is no coupler on the coupler microphone and that the microphones are correctly positioned for test box calibration.
- Check that the coupler microphone is securely plugged into the correct socket.
- Follow the suggestions in No test box reference mic. detected.

## **No on-ear ref. mic. detected**

*No on-ear reference mic. detected.*

This message may be displayed when starting an On-ear test. It indicates that the RM500SL is not measuring any sound at the on-ear probe reference microphone.

- Check that a probe microphone assembly is securely plugged into the PROBE socket to the left of the test chamber and that its cable has not become damaged.
- Unplug the test box reference microphone in the test chamber and plug the on-ear probe microphone in its

place. Try Test box calibration using the reference microphone of the on-ear probe microphone in place of the test box reference microphone. If this fails, the on-ear probe microphone is defective and must be replaced.

## Invalid on-ear calibration

*Invalid on-ear microphone calibration!*

This message may be displayed during the on-ear calibration procedure. It indicates that the calibration curve is significantly different from what is expected. It may be accompanied by an on-ear reference microphone error.

- Check that a probe microphone assembly is securely plugged into the PROBE socket to the left of the test chamber and that the cable has not become damaged.
- Try using a new probe tube. Ensure it is correctly attached and positioned.

## Invalid RECD transducer coupler calibration

*Invalid RECD transducer coupler calibration.*

This message may be displayed during the coupler calibration for the RECD transducer. It indicates that the calibration is significantly different from normal which may cause significant error while fitting.

- Check that the RECD transducer is connected.
- Check that the RECD transducer is inserted into the HA-2 coupler and the HA-2 coupler is tightly attached to the coupler microphone.
- Check that the coupler microphone is connected.

## Invalid RECD real ear measurement

*Invalid RECD real ear measurement.*

This message may be displayed during the RECD real ear measurement. It indicates that the measurement is significantly different from normal which may cause significant error while fitting.

- Check that the RECD transducer is connected.
- Check that the probe module is connected. Ensure the probe tube is not pinched or blocked.
- Check that the RECD transducer is inserted to inserted into the ear that is under test.

## Barcode scanner malfunction

If there is no red scanning beam when the trigger is pulled, tug on the cable where it enters the scanner. If it comes loose easily, push it back in until it clicks in place.

If the scanning beam stays on when the trigger is released or if the barcode scanner fails to read known good barcodes, try the following:

1. Unplug the scanner from the equipment, then reconnect it. If the problem persists...
2. Print this page on an external printer (see External display, printer, speaker) or from the electronic user's guide (see Electronic user's guide).
3. If your barcode scanner has a PSC logo, scan these two barcodes, starting with the top one. This will reset the scanner to its default settings.

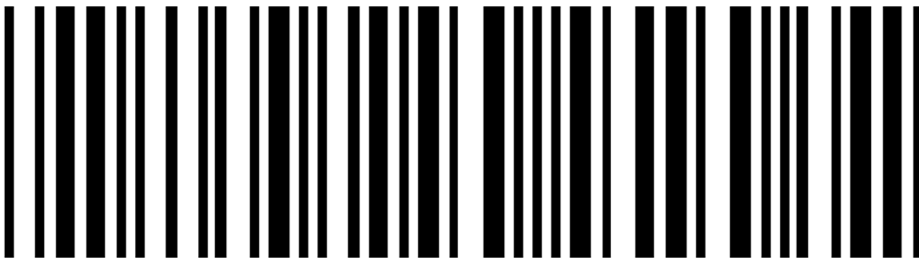
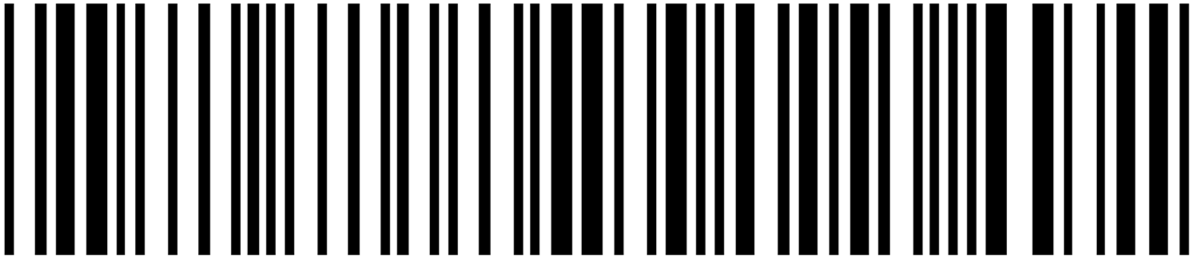

If your scanner has a Unitech logo, scan the following barcode to reset the scanner to its default settings.

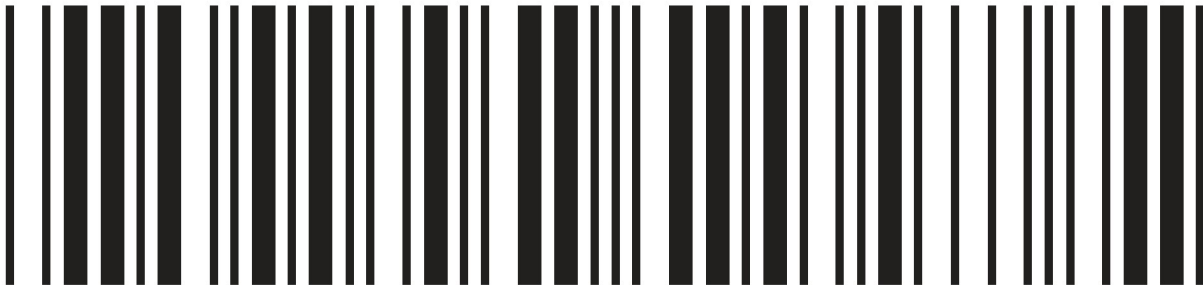





## 22 Technical Specifications

Specifications subject to change without notice

### Environmental conditions

#### STORAGE & TRANSPORTATION

### Temperature - 20° C to +60° C

Relative humidity (non-condensing).....5% to 95%  
**OPERATING**  
 Temperature.....+15° C to +30° C  
 Relative Humidity.....20% - 50%  
 Atmospheric Pressure.....81 - 106 kPa  
 Altitude.....below 2000 m

### General

Power source:.....100 – 240 V, 50 – 60 Hz, 250 VA  
 Fuse:.....T2AL , 250 V  
 Overall dimensions.....15.5"x12.75"x4.25"  
 Weight.....16.4 lb (7.5 kg)  
 Display type.....fluorescent backlit active color  
 Display size.....12.1" diagonal  
 Resolution.....800x600 (SVGA)  
 Printer type.....thermal line printer  
 Printer resolution.....200 dots per inch  
 Paper width.....3" (80mm)  
 Power amplifiers.....2  
 Stimulus Channels.....2  
 Measurement channels.....1  
 Connectors.....1-USB  
 .....1 - Ethernet (RJ45)  
 .....2 - auxiliary audio outputs (1/4" mono)  
 .....1- RECD transducer(3.5mm st)  
 .....1 - test chamber ref. mic.(3.5mm st)  
 .....1 - coupler microphone(3.5mm st)  
 .....1 - battery substitute(3.5mm st)  
 .....1 - real-ear mic.(3.5mm st)

### Test box

Working Space.....8.8"x3.5"x1.5"  
 Speaker.....1 - 2"x3"  
 Test box isolation @ 1kHz.....>25 dB  
 Induction Coils..1 - Telephone Magnetic Field Simulator  
 .....(TMFS ANSI S3.22 - 2003)  
 Battery Simulator.....per ANSI S3.22 2003  
 Frequency Range.....200 - 8000 Hz  
 Coupler microphone noise floor.(200 – 8000 Hz) <40 dB SPL

Test Stimuli.....tone, tone burst,pink noise,  
 .....calibrated or live speech  
 Test stimulus levels.....40 to 90 dB SPL in 5 dB steps  
 Test stimulus levels (inductive).....31.6mA/m per  
 .....(ANSI S3.22 - 2003)  
 Test stimulus distortion.....<2% at 90dB SPL  
 .....<0.5% at 70 dB SPL  
 Test stimulus accuracy at reference mic. for tones  
 (200-2000 Hz).....±1.5 dB SPL  
 (2000-8000 Hz).....±2.5 dB SPL  
 Equalization method.....pressure method  
 Analysis frequencies per octave.....12  
 Analysis filter bandwidth.....1/12 octave  
 Measurement accuracy at 1 kHz.....±1db  
 Measurement accuracy re 1 kHz.±1 dB (200-5000 Hz)  
 .....±2.5 dB (5000-8000 Hz)  
 Measurement range.....30 - 140 dB SPL  
 Harmonic distortion measurement.....2nd, 3rd  
 .....or 2nd plus 3rd  
 Harmonic distortion range.....200 to 4000 Hz  
 Harmonic distortion accuracy.....±1%  
 Battery drain range.....0 - 20mA  
 Battery drain accuracy.....±5%  
 Battery drain resolution.....±0.01 mA

ANSI S3.22 - 1996 and 2003 tests available

..... OSPL90  
 ..... Full-on Gain  
 ..... Reference Test Gain  
 ..... Frequency Response  
 ..... Frequency Range  
 ..... Maximum OSPL90  
 ..... Harmonic Distortion  
 ..... Attack & Release time  
 ..... Equivalent Input Noise  
 ..... Input/Output Curves  
 ..... Coupler SPL - Telephone Simulator  
 ..... Simulated Telecoil Sensitivity  
 .. Battery Drain (optional battery substitutes required)

Other tests Available

..... Speechmap @ real-speech audibility measures  
 ..... Coupler SPL vs frequency  
 ..... Coupler gain vs frequency  
 ..... Spectral analysis  
 ..... Distortion vs frequency  
 ... Manual measurement of output, gain and distortion

### On-Ear

Speakers.....1 - 2"x 3"  
 Probe microphone tube.....1.0 mm diameter x 75 mm  
 Probe microphone noise floor (200 – 8000 Hz).<45 dB SPL  
 Frequency Range.....200 to 8000 Hz  
 Test Stimuli.....frequency-modulated tone, tone burst,  
 .....pink noise, calibrated or live speech  
 Freq. modulation.....sawtooth ±3% over 128 ms  
 Stimulus levels for tones.40 - 85 dB SPL in 5 dB steps

Test stimulus accuracy at reference mic. for tones  
(2000- 8000 Hz).....±3 dB SPL  
Equalization Method.....modified pressure method  
.....(stored for open fittings)  
Frequencies per octave (swept tones).....12  
Frequencies per octave (tone burst).....3  
Analysis bandwidth (speech, noise).....1/3 octave  
Measurement accuracy at 1 kHz.....±1 dB  
Measurement accuracy re 1 kHz.±1.5 dB (200-5000 Hz)  
.....±2.5 dB (5000-8000Hz)  
Measurement Range...30-135 dB SPL (200-2500 Hz)  
.....30-140 dB SPL (2500-8000Hz)  
ANSI S3.46 - 1997 tests available  
..... Real-Ear Unaided Response  
..... Real-Ear Aided Response  
..... Real-Ear Occluded Response  
..... Real-Ear Insertion Gain  
Other tests available  
..... Speechmap ® real-speech audibility measures  
..... On-ear harmonic distortion  
..... On-ear spectral analysis  
..... On-ear noise reduction verification  
... Manual measurement of output, gain and distortion  
Fitting methods available  
.Speechmap with DSL 5.0a, NAL-NL1, NAL-NL2, CAMFIT  
.. Insertion gain with NAL-RP, NAL-NL1, Fig6, Pogoll,  
.....Berger, Libby

## Sensory Loss Simulator

Simulation types.....Linear conductive  
.....Non-linear outer hair cell cochlear loss  
Simulation bands.....65



## 23 Glossary

**AGC, Automatic Gain Control**, the means by which gain is automatically controlled by the level of the signal being amplified. (ANSI S3.22)

**AGC-I**, input-controlled AGC (see "input compression").

**AGC-O**, output controlled AGC (see "output compression").

**AGRAM**, Abbreviation for audiogram.

**ANSI**, American National Standards Institute.

**Attack Time**, the time required for HA output to reach +/- 3dB of its steady state level in response to an input step from 55 to 90dB SPL. (ANSI S3.22)

**ASP, Automatic Signal Processing**, In hearing aids, level dependent frequency response shaping.

**AVC, Automatic Volume Control**, slow-acting AGC that attempts to maintain a constant average signal level.

**BSPL, Band Sound Pressure Level**, the SPL within a restricted frequency band.

**BTE**, Behind-The-Ear (hearing aid).

**Compression**, a type of AGC in which an incremental change in the input level produces a smaller incremental change in the output level.

**CR, Compression Ratio**, the ratio of incremental change in input SPL to the resulting incremental change in output SPL. Used to characterize steady state AGC action; can be a function of input level, duration and frequency.

**CROS, Contralateral Routing Of Signals**; a type of hearing aid in which the microphone is at the ear opposite to the one receiving the amplified sound.

**CORFIG, coupler response for flat insertion gain**; the transformation added to real-ear insertion gain to obtain 2-cc coupler gain. Assumes linear amplification.

**Coupler**, a device used to acoustically couple an earphone or hearing aid to a measurement microphone and to provide an acoustic load.

**DSL, Desired Sensation Level Method**, a systematic eardrum (SPLogram) approach to the hearing aid fitting process that seeks to ensure amplified speech will be audible and comfortable while loud sounds will not be uncomfortable.

**Directional hearing aid**, a hearing aid for which the gain is dependent on the direction of sound incidence when measured under free-field conditions (ANSI S3.22).

**Equalization**, process of controlling the SPL (or band SPL) of the stimulus, as a function of frequency, at the field reference point (ANSI S3.46).

**Expansion**, a type of AGC in which an incremental change in the input level produces a larger incremental change in the output level.

**FM, frequency modulation**, a method of transmitting information in which the frequency of a radio wave (carrier) is varied (modulated) by the information (signal). Also, a method of reducing standing waves in a sound field in which the frequency of a test tone (carrier) is varied by a low frequency triangle or sine wave.

**FM System**, an assistive listening device consisting of a microphone, an fm radio transmitter and an fm receiver. The microphone and transmitter are worn by the speaker and the receiver is worn by the listener.

**FOG, full on gain**, gain for a 50 dB input SPL with the gain control set to maximum (ANSI S3.22)

**Gain (in dB)**, output sound pressure relative to input sound pressure, expressed in decibels;  $\text{gain} = 20\log_{10}(\text{output sound pressure} / \text{input sound pressure})$ ; also,  $\text{gain} = (\text{output SPL}) - (\text{input SPL})$ .

**Gain control**, a manually or electronically operated control for the adjustment of overall gain (ANSI S3.22).

**HA-1 Coupler**, a coupler having a volume of 2 cubic centimetres with direct access to the cavity. Used for testing in-the-ear and in-the-canal hearing aids; can also be used to test behind-the-ear hearing aids with a custom earmold attached. Aka the ITE coupler.

**HA-2 Coupler**, a coupler having a volume of 2 cubic centimetres with access through a rigid tube. When used for testing BTE hearing aids, the rigid tube consists of 18 mm of 3 mm tubing plus 25 mm of 2 mm tubing (ANSI S3.22). When used for calibrating insert earphones, the 2 mm tubing is not used (ANSI S3.6). Aka the BTE coupler.

**Harmonic**, a component of a tone complex that is an integer multiple of the lowest frequency component (fundamental).

**Harmonic Distortion**, the addition of harmonic components to a signal. The rms value of a harmonic component of a signal as a percentage of the rms value of the fundamental. If less than 20%, the rms value of the total signal may be used instead of the fundamental.

**HFA, High Frequency Average**, the average of values in dB at 1000, 1600, and 2500 Hz. (ANSI S3.22).

**HL, Hearing Level**, the hearing threshold referenced to the threshold of normal hearing, expressed in dB.

**HI**, Hearing instrument.

**Input Compression**, a form of AGC in which the signal level is regulated before the volume control.

**Input / Output function**, steady state, single-frequency plot of the coupler SPL on the ordinate as a function of input SPL on the abscissa with equal decibel scale divisions on each axis (ANSI S3.22).

**ITE**, In-The-Ear (hearing aid).

**Kneepoint** (compression threshold), the point on an input/output curve at which the slope digresses from unity indicating the signal level at which a non-linear process begins to take effect.<sup>1</sup>

**LCD**, liquid crystal display. A thin, planar information display.

**Linear Region**, that portion of the input-output function which is a straight line at 45 degrees.

**Linear Amplification**, amplification having the same gain for all input levels until the maximum output of the device is reached.

**LTASS, Long-term average speech spectrum**, the rms level of a speech passage in 1/3rd octave bands, averaged over the entire passage.

**Loop System**, an assistive listening device that uses magnetic induction to carry a signal from a microphone/amplifier to a wire loop. The signal is picked up from the loop by a hearing aid set to the telecoil position or by a receiver with built-in telecoil, volume control, and earpiece. Loops are either worn around an individual's neck or can encircle a room, such as a classroom, providing an excellent signal-to-noise ratio.<sup>1</sup>

**MAF, minimum audible field**, SPL of a tone at the threshold of audibility measured in a free sound field for a subject listening with both ears and facing the sound source. The SPL is measured with the subject removed from the field at the midpoint of an imaginary line joining the centers of the ear canal openings.

**MAP, minimal audible pressure**, SPL of a tone, measured or inferred at the tympanic membrane, at the threshold of audibility.

**MPO, Maximum Power Output**, the maximum SPL that a hearing aid can deliver in response to a steady narrow band input. The stimulus may be pulsed (a tone burst) to avoid discomfort and to approximate an aided UCL measurement stimulus.

**Modulation**, the process of varying a characteristic of one signal with another.

**NAL**, National Acoustic Laboratories (Australia)

**NCA**, National Centre for Audiology (Canada)

**Nonlinear Region**, that portion of the input-output function which is not a straight line at 45 degrees.

**OSPL90** (output SPL for 90-dB input SPL), The SPL developed in a 2cc coupler when the input SPL is 90 dB, with the gain control of the hearing aid full-on (ANSI S3.22).

**Oscillation**, in audiology, refers to the undesired tonal output of an amplifier behaving unstably as a result of feedback; whistling.<sup>1</sup>

**Output Compression**, a form of AGC in which the signal level is regulated at the output.

**OLC, Output-limiting Compression (compression limiting)**, a form of AGC with a high kneepoint and high compression ratio.

**PC, Peak-clipping**, a method of limiting MPO by truncating the electrical signal supplied to the output transducer. The resulting acoustic signal may not be truncated but will be distorted.

**PCR, Power Concentration Ratio**, a measure of the degree to which a large amount of power is concentrated at a small number of frequencies in the output of a hearing aid.

**Probe microphone**, microphone (which may include an extension tube) having a sound inlet which is small enough to be acoustically unobtrusive when inserted into the ear canal (ANSI S3.46).

**Pure tone**, a signal containing one, and only one, frequency; a sinusoidal acoustic signal.<sup>1</sup>

**REAG, Real-Ear Aided Gain**, difference, in dB as a function of frequency, between the SPL (or BSPL) at a specified measurement point in the ear canal and the SPL (or BSPL) at the field reference point, for a specified sound field, with the hearing aid in place and turned on (ANSI S3.46).

**REAR, Real-ear Aided Response**, the SPL (or BSPL) as a function of frequency, at a specified measurement point in the ear canal for a specified sound field, with the hearing aid in place and turned on (ANSI S3.46).

**RECD, Real-Ear-to-Coupler Difference**, difference, in dB as a function of frequency, between the SPL (or BSPL) produced by an insert transducer at the eardrum and in a 2cc coupler. HA-1 or HA-2 coupler should be specified.

**REDD, Real-Ear-to-Dial Difference**, difference, in dB as a function of frequency, between the SPL (or BSPL) measured at the eardrum and the audiometer dial setting that produced it. It is specific to the client, headphone and audiometer used to generate it.

**REIG, Real-Ear Insertion Gain, difference**, in dB as a function of frequency, between the REAG and the REUG taken with the same measurement point and the same sound field conditions.  $REIG = REAG - REUG$ . ANSI S3.46.

**REOG, Real-Ear Occluded Gain**, difference, in dB as a function of frequency, between the SPL (or BSPL) at a specified measurement point in the ear canal and the SPL (or BSPL) at the field reference point, for a specified sound field, with the hearing aid in place and turned off (ANSI S3.46).

**REOR, Real-Ear Occluded Response**, SPL (or BSPL), as a function of frequency, at a specified measurement point in the ear canal, for a specified sound field, with the hearing aid in place and turned off (ANSI S3.46). The

REOR is used to evaluate the seal of an earmold. It is not related to the required gain of a hearing aid.

**REUG, Real-Ear Unaided Gain**, difference, in dB as a function of frequency, between the SPL (or BSPL) at a specified measurement point in the ear canal and the SPL (or BSPL) at a field reference point, for a specified sound field, with the ear unoccluded (ANSI S3.46).

**REUR, Real-ear Unaided Response**, SPL (or BSPL), as a function of frequency, at a specified measurement point in the ear canal, for a specified sound field, with the ear canal unoccluded (ANSI S3.46).

**Reference microphone**, microphone used to measure the stimulus level in the measurement process or to control it in the equalization process.

**Release Time**, the time required for HA output to fall to within +/-4dB of its steady-state level for an input step from 90 to 55dB SPL. (ANSI S3.22)

**REM**, Real-ear Measurement.

**RTG, Reference Test Gain**, the HFA gain for a 60 dB input SPL with the gain control at RTS (ANSI S3.22).

**Reference**, Sound-field, the calibration point of a sound-field measurement.

**RSETS, Relative Simulated Equivalent Telephone Sensitivity**, difference in dB between the HFA-SPLITS (SPA-SPLITS) and the RTG plus 60 in the 'M' (microphone) mode.  $RSETS = HFA-SPLITS - (RTG+60)$

**RTS, Reference Test Setting of the gain control**, for a 60 dB input SPL, the setting of the gain control required to produce an HFA gain within 1.5 dB of the HFA-OSPL90 minus 17 dB. If the full-on HFA gain is less than the HFA-OSPL90 minus 17 dB, the RTS is the full-on setting of the gain control (ANSI S3.22).

**Saturation**, in a hearing aid, the limiting of output caused by the output circuitry and transducer reaching their maximum capability.

**SPA, Special Purpose Average**, the average of values in dB at three third octave frequencies separated by 2/3 of an octave (ANSI S3.22). See also HFA.

**Spectrum**, the BSPL as a function of frequency for a broad-band signal.

**SII, Speech Intelligibility Index**, a quantity calculated from measures of speech, noise and hearing threshold that is highly correlated with the intelligibility of speech (ANSI S3.5).

**Speech Region**, a statistical range of short-term spectra present in a speech passage. The short-term spectra are typically 120 - 130 millisecond averages in 1/3 octaves. The statistical range is typically from the 70th to the 99th percentile.

**SPL, Sound Pressure Level**, rms sound pressure relative to 20 uPa, expressed in decibels.  $SPL = 20\log_{10}(\text{rms sound pressure} / 20\text{uPa})$ .

**SPLITS, coupler SPL for an inductive telephone simulator**, SPL developed in a 2cc coupler by a hearing aid with the gain control at the RTS when the input is the magnetic field generated by a TMFS (ANSI S3.22).

**TMFS, Telephone magnetic-field simulator**, a device for producing a magnetic field of consistent level and geometric shape when driven by a specified current (ANSI S3.22).

**THD, Total Harmonic Distortion**, the power in all harmonic components as a percentage of the power in the fundamental. If less than 20%, the power of the total signal may be used instead of the fundamental. For most hearing aids, the inclusion of harmonics above the third will not significantly alter the THD (ANSI S3.22).

**Transducer**, a device which transforms energy from one form to another. For example, a microphone or earphone.

**UCL, Uncomfortable Listening Level**, the level for a specified stimulus that is judged to be definitely

uncomfortable.

**VGA**, video graphics adapter.

**VC, Volume Control**, a user-operated gain control.

**Warble Tone**, a frequency-modulated sine wave. The modulating signal is often a low frequency triangle wave.

1. Valente, M: *Strategies for Selecting and Verifying Hearing Aid Fittings*. New York:Thieme Medical Publishers, Inc.,1994.

ANSI S3.5, *Methods for Calculation of the Speech Intelligibility Index*, 1997

ANSI S3.6, *Specification for Audiometers*, 1996

ANSI S3.22, *Specification of Hearing Aid Characteristics*, revised 2003.

ANSI S3.46, *Methods of Measurement of Real-Ear Performance Characteristics of Hearing Aids*, 1997.



## 24 References

- AAA Clinical Practice Guidelines: *Remote Microphone Hearing Assistance Technologies for Children and Youth Birth-21 Years*. Supplement A: Fitting and Verification Procedures for Ear-level FM. Draft 2007.
- American National Standards Institute. (1997). *American National Standard Methods of Measurement of Real-Ear Performance Characteristics of Hearing Aids*. ANSI S3.46-1997. New York: American National Standards Institute.
- American National Standards Institute. (1996). *American National Standard Specification of Hearing Aid Characteristics*. ANSI S3.22-1996. New York: American National Standards Institute.
- Bagatto, M., Moodie, S. T., Scollie, S., Seewald, R., Moodie, K.S., Pumford, J. & Liu, R. (2005). *Clinical protocols for hearing instrument fitting in the desired sensation level method*. Trends in Amplification, 9-4, 199-226.
- Bentler, R.A. & Pavlovic, C.V. (1989). *Transfer functions and correction factors used in hearing aid evaluation and research*. Ear and Hearing, 10(10),58-63.
- Byrne, D. (1977). *The speech spectrum - Some aspects of its significance for hearing aid selection and evaluation*. British Journal of Audiology, 11,40-46.
- Cole, W.A. & Sinclair, S.T. (1998). *The Audioscan RM500 Speechmap/DSL fitting system*. Trends in Amplification, 3(4):125-139.
- Corliss, E. L. R. (1990) *The ear as a mechanism of communication*. Journal of Audio Engineering Society, 38(9):640-652.
- Cornelisse, L.E., Gagne, J-P & Seewald, R.C. (1991). *Ear level recordings of the long-term average spectrum of speech*. Ear and Hearing, 12(1),47-54.
- Cornelisse, L.E., Gagne, J-P & Seewald, R.C. (1991). *Long-term average speech spectrum at chest-level microphone location*. Journal of Speech, Language, Pathology and Audiology, 15(3):7-12.
- Cornelisse, L.E., Seewald, R.C., & Jamieson, D.G. (1994). *Wide-dynamic-range compression hearing aids: The DSL[i/o] approach*. The Hearing Journal, 47(10), 23-29.
- Cornelisse L.E., Seewald R.C., & Jamieson D.G. (1995). *The input/output (I/O) formula: A theoretical approach to the fitting of personal amplification devices*. Journal of the Acoustical Society of America, 97(3), 1854-1684.
- Cox, R.M. & Moore, J.N. (1988). *Composite speech spectrum for hearing aid gain prescriptions*. Journal of Speech and Hearing Research, 31:102-107.
- Dunn, H. K., & White, D. S. (1940). *Statistical measurements on conversational speech*. Journal of the Acoustical Society of America, 11:278-288.
- Feigin, J.A., Kopun, J.G., Stelmachowicz, P.G. & Gorga, M.P. (1989). *Probe-tube microphone measures of ear-canal sound pressure levels in infants and children*. Ear and Hearing, 10(4), 254-258.
- Fikret-Pasa, S. & Revit, L.J. (1992). *Three experiments to validate new probe-measurement practices in prescribing customized hearing aids*. Journal of Speech and Hearing Research, 35:384-400.
- Freed, D.J., & Soli, S. D (2006). *An objective procedure for evaluation of adaptive antifeedback algorithms in hearing aids*. Ear & Hearing, 27(4).
- Hawkins, D.B., Cooper, W.A., & Thompson, D.J. (1990). *Comparisons among SPLs in Real Ears, 2cc and 6cc couplers*. Journal of the American Academy of Audiology 1:154-161.

- Hawkins, D.B., Walden, B.E., Montgomery, A.A., & Prosek, R.A., (1987). *Description and validation of an LDL procedure designed to select SSPL90*. *Ear and Hearing*, 8:162-169.
- Killion, M. C., & Monser, E. L. (1980). "Corfig: Coupler response for flat insertion gain." In G. A. Studebaker and I. Hochberg (Eds.), *Acoustical Factors Affecting Hearing Aid Performance*. Baltimore: University Park Press.
- Lewis, D.E., Feigin, J.A., Karasek, A.E., & Stelmachowicz, P.G. (1991). *Evaluation and assessment of FM systems*. *Ear and Hearing*, 12:268-280.
- Martin, H.C., Munro, K.J., & Langer, D.H. (1997). *Real-ear to coupler differences in children with grommets*. *British Journal of Audiology* 31:63-69.
- Moodie, K.S. (1996). *A practical approach to hearing aid selection*. *BSA News* 18:6-8.
- Moodie, K.S., Seewald, R.C. & Sinclair, S.T. (1994). *Procedure for predicting real-ear hearing aid performance in young children*. *American Journal of Audiology*, 3(1), 23-31.
- Moore, Brian C.J. & Glasberg, Brian R. (2004). *A revised model of loudness perception applied to cochlear hearing loss*. *Hearing Research*, 188 (2004), 70-88.
- Mueller, H.G. & Bright, K.E. (1994). Selection and verification of maximum output. In Valente M (ed.): *Strategies for Selecting and Verifying Hearing Aid Fittings*. New York: Thieme Medical Publishers, 38-63.
- Pavlovic, C. V. (1991). *Speech recognition and five articulation indexes* *Hearing Instruments* 42(9):20-23.
- Pearsons, K.S., Bennett, R.L., & Fidell, S. (1977). *Speech levels in various noise environments, Project Report On Contract 68 01-2466*. Washington, DC: US Environmental Protection Agency.
- Platz, Rainer, (2004). *SNR Advantage, FM Advantage and FM Fitting, Proceedings from the 1st International FM Conference*. [www.phonak.com](http://www.phonak.com).
- Scollie, S.D., Seewald, R.C., Cornelisse, L.E. & Jenstad, L.M. (1998). *Validity and repeatability of level-independent HL to SPL transforms*. *Ear and Hearing* 19(5):407-413.
- Scollie, S.D., Seewald, R.C., Moodie, K.S., Dekok, K. (2000). *Preferred listening levels of children who use hearing aids: Comparison to prescriptive targets*. *JAAA* 11:230-238.
- Scollie, S., Seewald, R., Cornelisse, L., Moodie, S. T., Bagatto, M., Laurnagaray, D., Beaulac, S. & Pumford, J. (2005). *The Desired Sensation Level Multistage Input/Output Algorithm*. *Trends in Amplification*, 9-4, 159-197.
- Seewald, R.C. (1994a). Current issues in hearing aid fitting. In J-P Gagne and N. Tye-Murray (Eds.), *Research in Audiological Rehabilitation: Current Trends and Future Directions*. *Journal of the Academy of Rehabilitative Audiology Monograph*, XXVII.
- Seewald, R.C. (1994b). *Fitting children with the DSL method*. *The Hearing Journal*, 47(9), 10,48-51.
- Seewald, R.C., Moodie, K.S., Sinclair, S.T. & Cornelisse, L.E. (1996). *Traditional and theoretical approaches to selecting amplification for infants and young children*. In Bess, F.H., Gravel, J.S. &
- Tharpe, A.M. (eds.): *Amplification for Children with Auditory Deficits*, Nashville: Bill Wilkerson Center Press, 161-191.
- Seewald, R.C. & Ross, M. (1988). *Amplification for young hearing-impaired children*. In M.C. Pollack (Ed.), *Amplification for the Hearing-Impaired*, Third Edition (pp. 213-271). Orlando: Grune & Stratton.
- Seewald, R.C., Ross, M. & Spiro, M.K. (1985). *Selecting amplification characteristics for young hearing-impaired children*. *Ear and Hearing*, 6(1), 48-53.
- Seewald, R.C., Ross, M. & Stelmachowicz, P.G. (1987). *Selecting and verifying hearing aid performance*

- characteristics for young children.* Journal of the Academy of Rehabilitative Audiology, 20, 25-38.
- Seewald, R., Moodie, S. T., Scollie, S. & Bagatto, M. (2005). *The DSL method for pediatric hearing instrument fitting: Historical perspective and current issues.* Trends in Amplification, 9-4, 145-157.
- Seewald, R.C. & Moodie, K.S. (1992). Electroacoustic considerations. In M. Ross (ed), *FM Auditory Training Systems: Characteristics, Selection, & Use.* Timonium, MD: York Press.
- Sherbecoe, R.L & Studebaker, G.A. (2003) *Audibility-Index predictions of normal-hearing and hearing-impaired listeners' performance on the Connected Speech Test.* Ear and Hearing, 24-1, 71-88.
- Sinclair, S.T., Moodie, K.S. & Seewald, R.C. (1997). *Pediatric Hearing Instrument Fitting: Phonak Video Focus #2 Booklet,* Stofa, Switzerland: Phonak A/G.
- Sinclair, S.T. Seewald, R.C. & Cole, W.A. (1996). *A new real-ear fitting system: Because no two ears are alike.* Hearing Review 3(6):46-48.
- Skinner, M. W. (1988). *Hearing Aid Evaluation.* Englewood Cliffs: Prentice-Hall Inc.
- Smith, D. A. 1990. *Technological report: Acoustometry.* Hearing Instruments 41(11):40-44.
- Valente, M., Potts, L.G., Valente, M., Vass, W & Goebel, J. (1994). *Intersubject Variability of real-ear sound pressure level: Conventional and insert earphones.* Journal of the American Academy of Audiology, 5, 390-398.
- Valente, M: *Strategies for Selecting and Verifying Hearing Aid Fittings.* New York:Thieme Medical Publishers, Inc.,1994.
- Zelisko, D.L.C., Seewald, R.C. & Whiteside, S. (1992). *Comparing three procedures for predicting the ear canal SPL at LDL.* ASHA, 34(10).

## **25 Appendix 1**

### **Manufacturer Disclosure Statement for Medical Device Security**

Manufacturer Disclosure Statement for Medical Device Security – MDS <sup>2</sup>			
Device Category † <b>Hearing Aid Analyzer</b>	Manufacturer † <b>Etymonic Design Inc.</b>	Document ID	Document Release Date
Device Model <b>Verifit/RM500SL/Axiom</b>	Software Revision <b>See Page 1 of Users Guide</b>	Software Release Date: <b>See Page 1 of Users Guide</b>	
Manufacturer or Representative Contact Information:	Name <b>Chris Stokes-Rees</b>	Title <b>Technical Service Specialist</b>	Department
	Company Name <b>Etymonic Design Inc. / Audioscan</b>	Telephone # <b>800-265-2093</b>	e-mail <b>chris@audioscan.com</b>
<b>MANAGEMENT OF ELECTRONIC PROTECTED HEALTH INFORMATION (ePHI) As defined by HIPAA Security Rule, 45 CFR Part 164)</b>			<b>Yes No N/A Note #</b>
1. Can this device transmit or maintain <i>electronic Protected Health Information (ePHI)</i> ? <sup>†</sup>			<b>Yes 1</b>
2. Types of ePHI data elements that can be maintained by the device:			
a. Demographic (e.g., name, address, location, unique identification number)?			<b>No</b>
b. Medical record (e.g., medical record #, account #, test or treatment date, device identification number)?			<b>No</b>
c. Diagnostic/therapeutic (e.g., photo/radiograph, test results, or physiologic data with identifying characteristics)?			<b>No</b>
d. Open, unstructured text entered by device user/operator?			<b>Yes 1</b>
3. Maintaining ePHI: <i>Can the device</i>			
a. Maintain ePHI temporarily in volatile memory (i.e., until cleared on by power-off or reset)?			<b>Yes 2</b>
b. Store ePHI persistently on local media?			<b>No</b>
c. Import/export ePHI with other systems?			<b>Yes 3</b>
4. Mechanisms used for the transmitting, importing/exporting of ePHI: <i>Can the device</i>			
a. Display ePHI (e.g., video display)?			<b>Yes</b>
b. Generate hardcopy reports or images containing ePHI?			<b>Yes 1</b>
c. Retrieve ePHI from or record ePHI to removable media (e.g., disk, DVD, CD-ROM, tape, CF/SD card, memory stick)?			<b>Yes 1</b>
d. Transmit/receive or import/export ePHI via dedicated cable connection (e.g., IEEE 1073, serial port, USB, FireWire)?			<b>No</b>
e. Transmit/receive ePHI via a network connection (e.g., LAN, WAN, VPN, intranet, Internet)?			<b>Yes 3</b>
f. Transmit/receive ePHI via an integrated wireless connection (e.g., WiFi, Bluetooth, infrared)?			<b>Yes 3, 10</b>
g. Other _____?			
<b>ADMINISTRATIVE SAFEGUARDS</b>			<b>Yes No N/A Note #</b>
5. Does manufacturer offer operator and technical support training or documentation on device security features?.....			<b>Yes 4</b>
6. What underlying operating system(s) (including version number) are used by the device? <b>custom build of Linux, based on kernel 3.4.47</b>			
<b>PHYSICAL SAFEGUARDS</b>			<b>Yes No N/A Note #</b>
7. Are all device components maintaining ePHI (other than removable media) physically secure (i.e., cannot remove without tools)?			<b>Yes</b>
8. Does the device have an integral data backup capability (i.e., backup onto removable media such as tape, disk)?			<b>No</b>
9. Can the device boot from uncontrolled or removable media (i.e., a source other than an internal drive or memory component)?			<b>Yes 5</b>
<b>TECHNICAL SAFEGUARDS</b>			<b>Yes No N/A Note #</b>
10. Can software or hardware not authorized by the device manufacturer be installed on the device?.....			<b>No</b>
11. Can the device be serviced remotely (i.e., maintenance activities performed by service person via network or remote connection)?			<b>No</b>
a. Can the device restrict remote access to specific devices or network locations (e.g., specific IP addresses)? ...			<b>No</b>
b. Can the device log provide an audit trail of remote-service activity?			<b>No</b>
c. Can security patches or other software be installed remotely?.....			<b>No</b>
12. Level of owner/operator service access to device operating system: <i>Can the device owner/operator</i>			
a. Apply device manufacturer-validated security patches?			<b>No</b>
b. Install or update antivirus software?			<b>No 6</b>
c. Update virus definitions on manufacturer-installed antivirus software?			<b>No 6</b>
d. Obtain administrative privileges (e.g., access operating system or application via local root or admin account)?			<b>No</b>
13. Does the device support user/operator specific ID and password?			<b>No</b>
14. Are access sessions terminated after a predetermined length of inactivity (e.g., auto logoff)?			<b>No</b>
15. Events recorded in device audit log (e.g., user, date/time, action taken): <i>Can the audit log record</i>			
a. Login and logout by users/operators?			<b>No 7</b>
b. Viewing of ePHI?			<b>No 7</b>
c. Creation, modification or deletion of ePHI?			<b>No 7</b>
d. Import/export or transmittal/receipt of ePHI?			<b>No 7</b>
16. Does the device incorporate an emergency access ("break-glass") feature that logs each instance of use?			<b>No</b>
17. Can the device maintain ePHI (e.g., by internal battery) during power service interruptions?			<b>No</b>
18. Controls when exchanging ePHI with other devices:			
a. Transmitted only via a physically secure connection (e.g., dedicated cable)?			<b>No</b>
b. Encrypted prior to transmission via a network or removable media?			<b>No 8</b>
c. Restricted to a fixed list of network addresses (i.e., host-based access control list)?			<b>No 9</b>
19. Does the device ensure the integrity of the ePHI data with implicit or explicit error detection/correction technology? ....			<b>No</b>

† Recommend use of ECRI's Universal Medical Device Nomenclature System (UMDNS).

Adapted from *Information Security for Biomedical Technology: A HIPAA Compliance Guide*, ACCE/ECRI, 2004.  
ACCE – the American College of Clinical Engineering; ECRI – formerly the Emergency Care Research Institute.

## Manufacturer Disclosure Statement for Medical Device Security – MDS<sup>2</sup>

### RECOMMENDED SECURITY PRACTICES

If possible, do not create ePHI. ePHI can only be created if a QWERTY keyboard is connected to the device. Not providing a keyboard is an effective way of restricting the creation of ePHI.

In the event that ePHI must be produced, the device is capable of outputting ePHI in several different forms as disclosed in this document. Any data containing ePHI should be de-identified before storing, whether it is to hard copy, network file, or USB. If de-identification is not possible physical access to the device or hard copies of data should be restricted to authorized personnel and saving to USB sticks should be prohibited.

### EXPLANATORY NOTES (from questions 1 – 19):

**IMPORTANT:** Refer to *Instructions for the Manufacturers Disclosure Statement for Medical Device Security* for the proper interpretation of information provided in this form.

1. The device, if equipped with a QWERTY keyboard allows the operator to enter free-form text when saving or printing data. This data can be stored and retrieved from a USB stick or network file.
2. If an operator enters a header for printing, that header will remain on the machine until it is cleared or overwritten.
3. The device can import and export data and headers that may include ePHI, but only in the event that PHI was entered by the operator. The device can import/export via network connection or transfer via USB stick.
4. This document along with available phone support constitutes our support for HIPAA compliance.
5. The Verifit and Axiom devices boot from internal flash memory. The RM500SL device boots from a USB memory stick. The devices can boot from removable media only if it contains software supplied by the manufacturer.
6. There is no virus protection software available for the device; it is not required as it is not possible to load or execute software on the device except that which is provided by the manufacturer.
7. The device does not use any password protection and there is no device audit log.
8. The device does not encrypt data and cannot save to encrypted media such as an encrypted USB. Any PHI produced by the device should be de-identified appropriately.
9. The device can connect to any networked computer to store and retrieve data, provided the user name and password is entered. Once the username and password is entered it is maintained by the device.
10. Wireless 802.11 network connection standard on Verifit, optional on Axiom, n/a for RM500SL.

Adapted from *Information Security for Biomedical Technology: A HIPAA Compliance Guide*, ACCE/ECRI, 2004.  
ACCE – the American College of Clinical Engineering; ECRI – formerly the Emergency Care Research Institute.

MDS<sup>2</sup> v 1.0 (2004-11-01)

Side 2

© 2004, HIMSS. All rights reserved.

## **26 Appendix 2**

### **AudioNote 2.1 VERIFIT and RM500SL Test Signals and Analysis**

For additional details of the signals and their analysis, see the appended AudioNote.

## Verifit & RM500SL Test Signals & Analysis

Bill Cole BAsC, PEng

### 1 Introduction

The Verifit and RM500SL are full-duplex dual-channel audio measurement systems designed for the testing and fitting of all types of hearing instruments and many assistive listening devices. They provide an acoustic test chamber for the testing of devices coupled to standard 2 cm<sup>3</sup> couplers as well as sound-field speaker(s) for on-ear measurement of hearing aid performance. The Verifit test chamber contains two loudspeakers for the functional testing of directional hearing instruments. Test signals are delivered to the device under test via the test chamber loudspeaker(s), the test chamber telephone magnetic-field simulator (TMFS), the test chamber magnetic field test loop (Verifit only) or the sound-field loudspeaker(s). Device output signals are measured in the 2 cm<sup>3</sup> coupler via the coupler microphone or in a real ear via the probe microphone. Data from the 2 cm<sup>3</sup> coupler may be viewed as coupler SPL, coupler gain or as estimated SPL in the ear canal (simulated real-ear measurements, S-REM). Data from the probe microphone may be viewed as ear canal SPL, as ear canal SPL re normal hearing threshold (i.e. dB HL), as insertion gain or as ear canal SPL in the context of an auditory area (Speechmap®).

### 2 The test signals

Sinusoidal, pseudo-random noise and digitized real speech signals are provided. Two signals derived from real speech, the International Speech Test Signal (ISTS) and the single-talker International Collegium of Rehabilitative Audiology (ICRA) signal, are also provided. Test signals are generated in real time by the digital signal processor (DSP) or played from 16 bit binary audio files stored in the on-board flash memory. In the Verifit, these audio files are up-loaded from the internal compact disc (CD) drive at power up. In order to provide a repeatable acoustic signal to the device under test, a reference microphone is used in conjunction with a digital control loop to maintain the desired band level at each frequency. Live audio (speech, music etc.) may also be used as a test signal but it is not controlled for spectrum or level.

#### *Some useful facts about broad-band signals*

Overall SPL is the SPL in a band containing all significant frequency components of the signal.

Spectrum level is the SPL in a band 1 Hz wide.

Band SPL is the SPL in a restricted frequency range. If the signal is uniform in the band, band SPL = Spectrum level + 10\*log(bandwidth).

A spectrum is the band SPL, or spectrum level, in a series of adjacent bands.

For a broad-band signal, the overall SPL is greater than the band SPL and the band SPL is greater than the spectrum level. For a pure tone, the overall SPL, the band SPL and the spectrum level are the same.

A white noise signal has a spectrum level that is independent of frequency (i.e. constant SPL per Hertz).

A pink noise signal has a spectrum level that is inversely proportional to frequency (i.e. constant SPL per octave).

A fractional octave band (e.g. 1/3 octave) has a bandwidth that is proportional to frequency.

A pink noise signal has a flat spectrum when analyzed in fractional-octave bands.

A critical band is a band within which the loudness of a continuously-distributed signal of constant SPL is independent of bandwidth.



## 2.1 Narrow-band signals

### 2.1.1 Sinusoidal (pure tones)

Sinusoidal signals are used in the ANSI hearing aid tests, in Multicurve 2 cm<sup>3</sup> frequency response tests (gain or output), in 2 cm<sup>3</sup> and on-ear single frequency (manual) tests, in Insertion gain tests and in tone-burst maximum output (MPO) tests. The MPO stimulus consists of a series 128ms tone bursts with 128ms gaps at an SPL of 90 dB SPL in the test box and 85 dB in the sound field. Frequencies used are 1/12 octave except for the MPO test which uses 1/3 octave frequencies. Levels from 40 to 90 dB SPL are available at the reference microphone. Control of the level at each frequency is maintained by measuring the frequency response of the signal path to the reference microphone 256 ms before each test using a 256 ms, 50 – 55 dB SPL, multi-tone complex or a 256 ms chirp, depending on the test to follow. Drive levels at each frequency are then set to achieve the desired band levels at the reference microphone. For on-ear measurements, tones are frequency modulated (triangle, ± 3% over 128 ms).

## 2.2 Broad-band signals

### 2.2.1 Pink Noise signal

The pink noise signal is available for Multicurve 2 cm<sup>3</sup> coupler gain and output frequency response measurements and for Insertion gain and Speechmap on-ear measurements. It is a pseudo-random signal composed of 1024 simultaneous tones summed to provide a crest factor of 12 dB. The spectrum of the pink noise signal is controlled by the reference microphone in conjunction with a digital feedback loop with a frequency resolution of 1/12 octave and a response time of about 1/3 of a second. Pink noise was selected as a test signal because it has equal energy per octave, producing a flat spectrum when analyzed in 1/12 or 1/3 octave bands. Figure 1 shows the 1/3 octave spectrum of the pink noise signal and the noise signal specified in ANSI S3.42-1997. Note that the ANSI S3.42-1997 spectrum represents speech peaks not the long-term average.

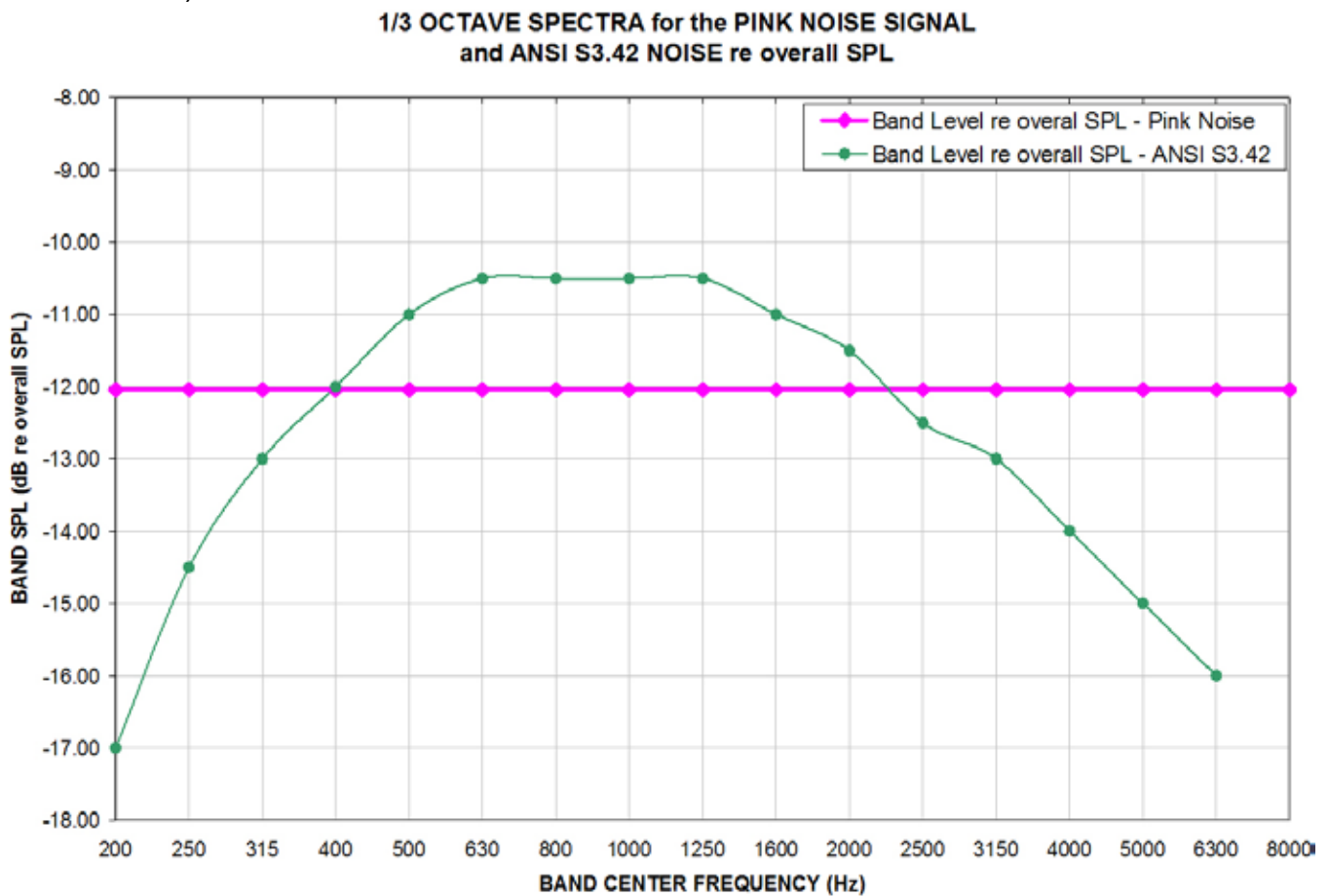
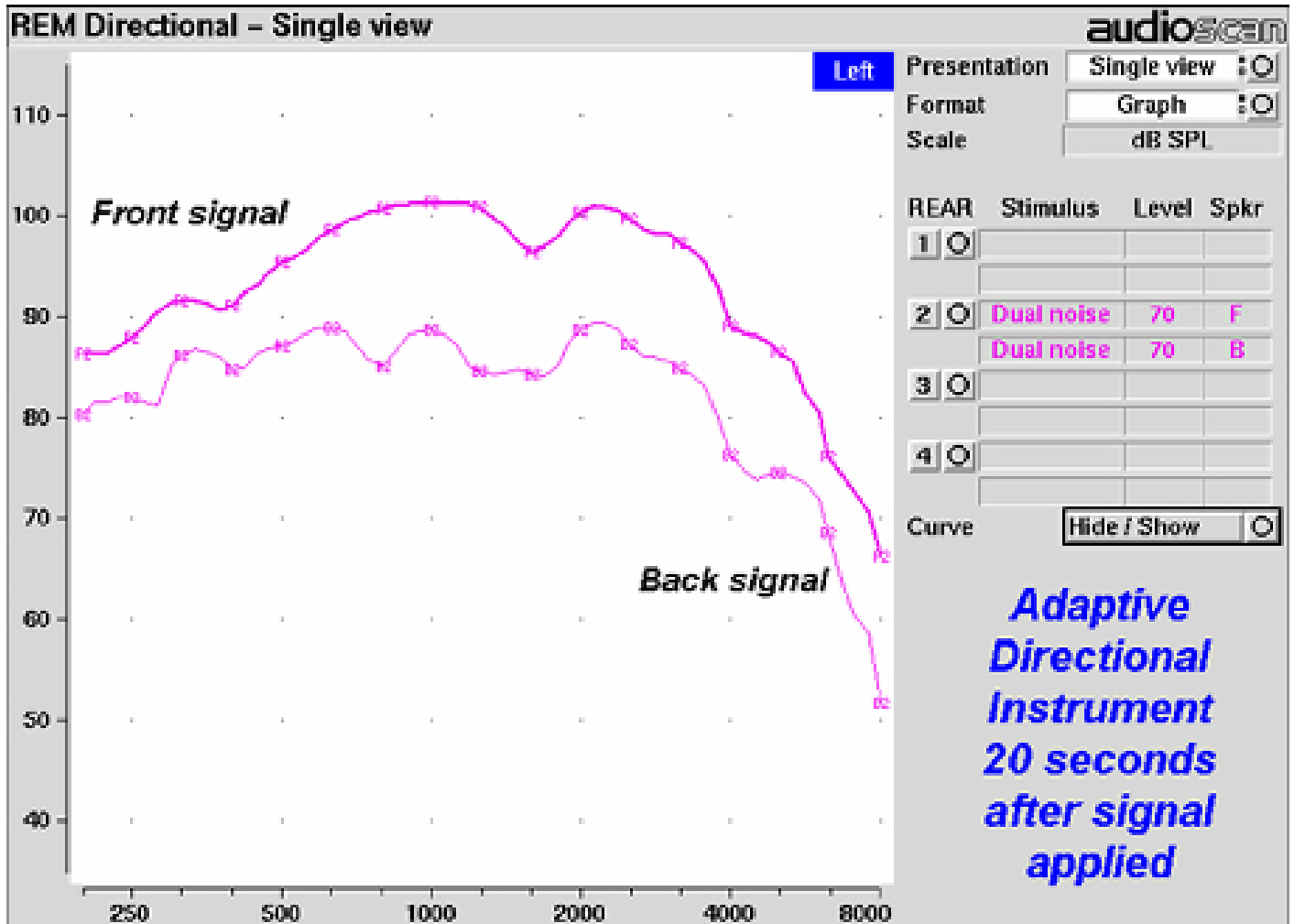

Figure 1: 1/3 octave spectra for the pink noise signal and the noise signal specified in ANSI S3.42-1997.

### 2.2.2 Dual-direction pink noise signal (Verifit only)

This unique test signal is available in the dual-source Verifit test chamber and for on-ear measurements by adding an additional sound-field speaker. It is similar to the pink noise signal described previously except that the component tones are presented simultaneously from two speakers, half from each. The spectrum of the tone complex from each speaker is independently controlled with 1/12 octave resolution

at the reference microphone. Two simultaneous response curves – one for each speaker – are derived from the measured output of the hearing aid. This provides a real-time measure of the functioning of the directional features of hearing aids that is independent of compression or noise reduction algorithms, unlike other methods that sequentially measure response from different directions and work only with these features disabled.



### 2.2.3 Real-speech signals

Real-speech signals are provided in Speechmap for both On-ear and Test box measurement modes. Four different digitized speech passages (2 male, 1 female and 1 child) are provided as well as the International Speech Test Signal (ISTS) and the single-talker International Collegium of Rehabilitative Audiology (ICRA) distorted speech signal. In addition, one of the speech passages has been filtered to provide 3 variations for evaluating frequency-lowering hearing aids. Each has a duration of 10 – 15 seconds and may be presented as a single passage or in a continuous loop. In order to provide a repeatable speech signal to the device under test, the signal path must be equalized prior to the presentation of the speech signal. This is accomplished by presenting a 896 ms pink noise burst at the selected speech level, 256 ms prior to the start of each speech passage and adjusting a digital filter to provide a flat response at the reference microphone.

The two “Speech-std” signals are by the same male talker, filtered to provide the long-term average speech spectrum (LTASS) recommended by Cox & Moore (1988) for average vocal effort. This is the LTASS assumed in the Desired Sensation Level (DSL) method of hearing aid fitting. In addition, four special versions of the Speech-std (1) test stimulus are provided in Speechmap to assist in the adjustment of frequency-lowering hearing aids. These are called Speech3150, Speech4000, Speech5000 and Speech6300. The Speech3150 stimulus has had the bands at 1000 Hz and above attenuated by 30 dB except for the 1/3 octave band at 3150 Hz which is unattenuated. Similarly, the Speech4000 stimulus has an unattenuated band at 4000 Hz, the Speech5000 stimulus has an unattenuated band at 5000 Hz and the Speech6300 stimulus has an unattenuated band at 6300 Hz (Figure 4). For these stimuli, the indicated level is for the unfiltered Speech-std (1) passage and the band levels in all unattenuated bands are the band levels present in the Speech-std (1) passage at that level. These three signals may be used to determine the amount of frequency shift provided by frequency-lowering hearing aids and the sensation level of the lowered components of the speech signal.

The “female” and “child” signals are presented “as recorded” without any processing and have been chosen to provide a range of spectra.

The ISTS was developed under the European Hearing Instrument Manufacturers Association (EHIMA) which holds the copyright. The sound file is available free of charge from the EHIMA website. The ISTS consists of 500 ms segments from recordings of 6 female talkers reading the same passage in American English, Arabic, Chinese, French, German and Spanish. These segments have been spliced together with appropriate pauses and filtered to match the average female spectrum from Byrne et al, An international comparison of long-term average speech spectra. *J. Acoust. Soc. Am.* 96 (1994), 2108-2120. For more details, consult the EHIMA website ([www.ehima.com](http://www.ehima.com)).

The ICRA distorted speech signal is a recording of an English-speaking talker that has been digitally modified to make the speech largely unintelligible. The resultant signal has many of the properties of real speech but has a harsh sound and lacks harmonic structure. The latter may be significant for hearing aids which use this property of speech to control noise reduction schemes. The LTASS is similar to the “Speech-std” signals up to 5 kHz.

Overall SPLs of 50, 55, 60, 65, 70 and 75 dB (at the reference microphone) are available. Soft and Average levels (50 - 70 dB SPL) have the same spectrum. A Loud vocal effort filter is applied to the 75 dB level signals. This is shown in Figure 5.

In the Test box mode in Speechmap (previously called S-REM) measurements made in the 2 cc coupler in the test chamber are converted to estimated real ear SPL. In this mode, the effects of hearing aid microphone location need to be included in the test signals so spectra are further altered to include the microphone location effects shown in Figure 6.

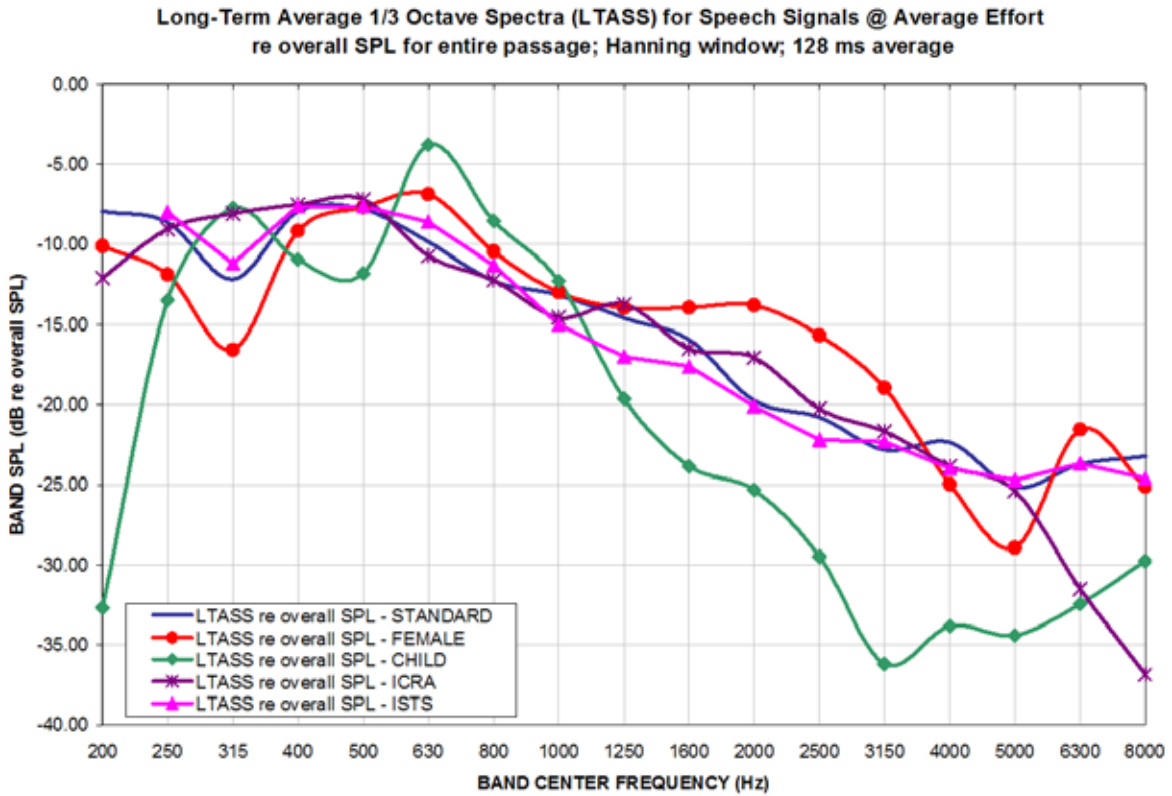

Figure 3: LTASS for Speechmap speech signals at average vocal effort

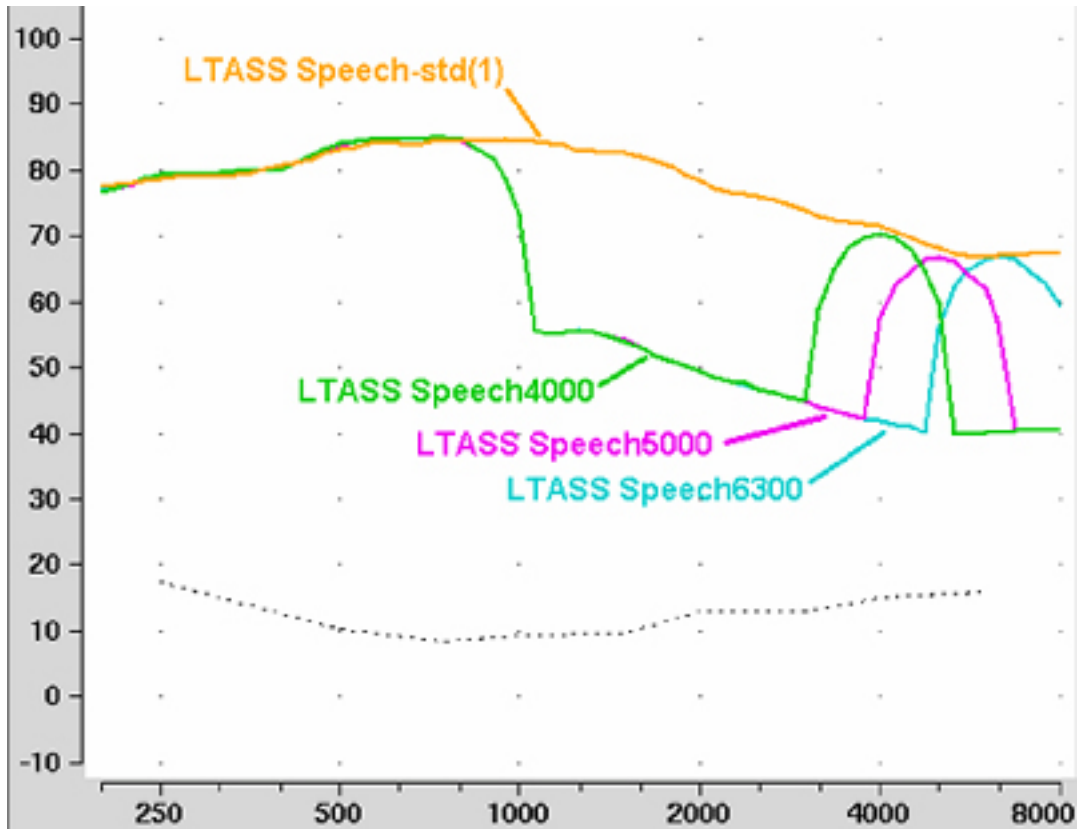

Figure 4: LTASS for Speech-std(1), Speech4000, Speech5000, Speech6300 for the FM boom location effects of Figure 6. Note that curves are 1/3 octave band levels at 1/12 octave intervals which causes the 1/3 octave bands at 4000, 5000 and 6300 Hz to appear broader than 1/3 octave. For clarity, the Speech3150 curve has been omitted.

LOUD VOCAL EFFORT EFFECT re nominal band SPL

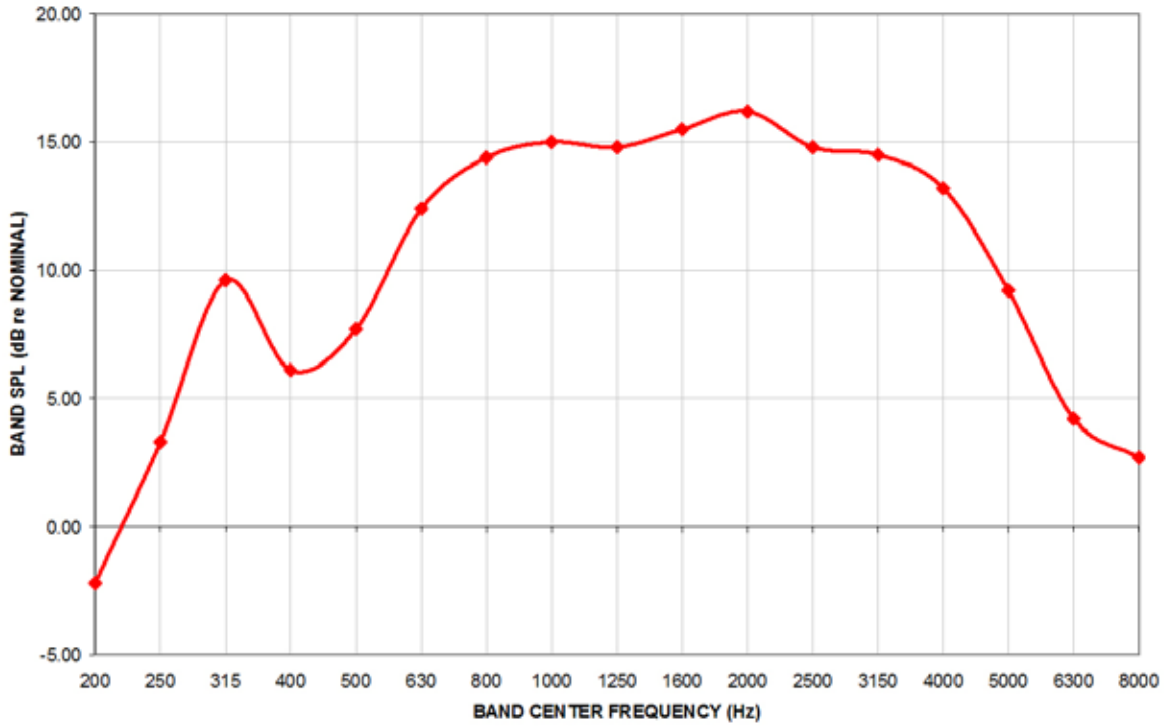

Figure 5: Loud vocal effort effect in dB re nominal band levels. Nominal band levels are band levels for an overall SPL of 65 dB. This shaping is applied to the 75 dB SPL speech and ICRA signals.

MICROPHONE LOCATION EFFECTS re nominal band SPL

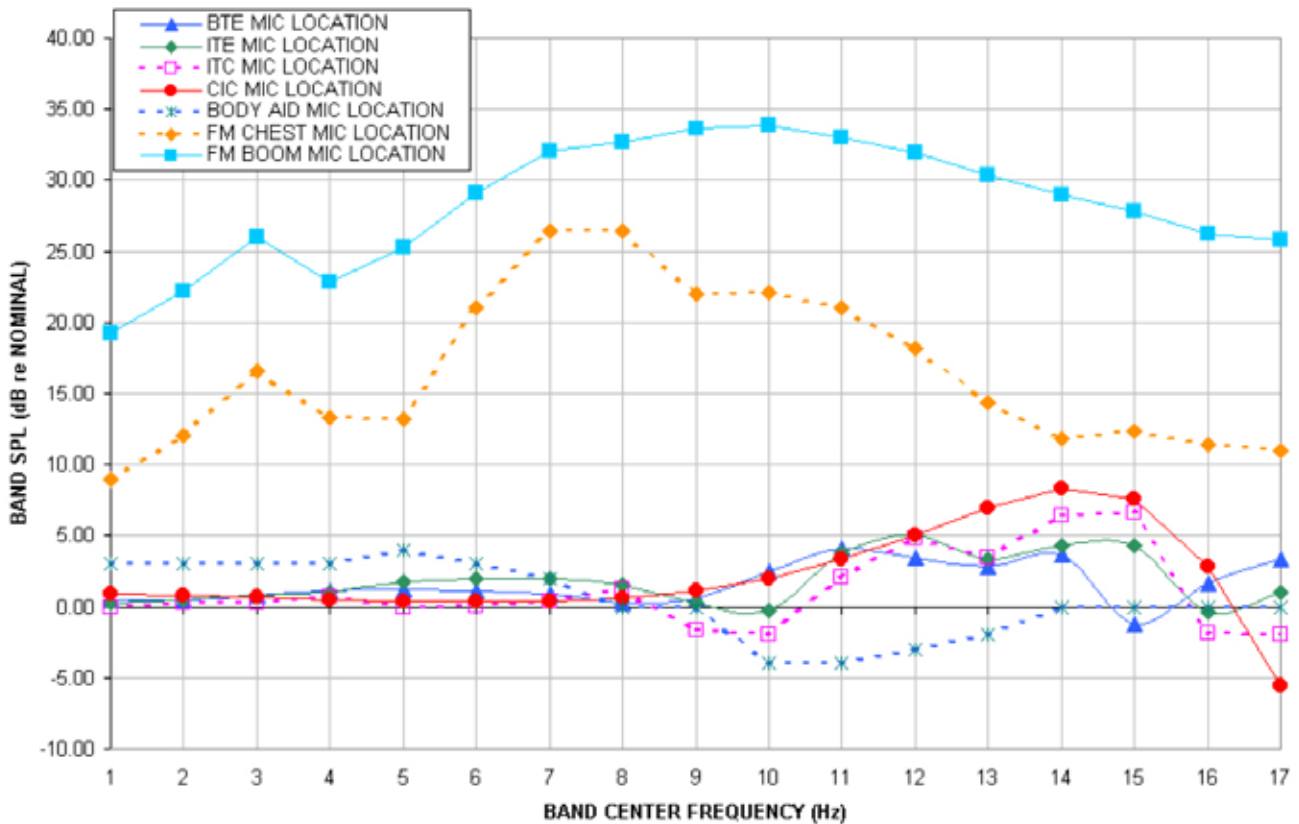

Figure 6: Microphone location effects in dB re nominal band SPL. Nominal band levels are band levels for an overall rms level of 65 dB SPL and average vocal effort in a free sound field.

In addition to these well-controlled and repeatable signals, live speech may be used as a test signal. It will, of course, be unequalized and at an uncontrolled level.

### 3 Analysis of broad-band signals

Broad-band signals contain energy at many frequencies simultaneously. Such signals are usually analyzed in a series of narrow frequency bands to produce a spectrum. The auditory system functions on a logarithmic frequency scale and analyzes broad-band signals in critical bands which approximate 1/3 octave bands (Figure 7). Using 1/3 octave bands for analysis of broad-band signals allows measured levels to be compared more readily to narrow-band behavioral measures, such as threshold. For this reason, analysis of broad-band signals in all On-ear measurements (including Speechmap Test box mode) is in 1/3 octave

bands. Other analyzers use narrower analysis bands, sometimes having constant bandwidth. As shown in Figure 7, this can result in significantly underestimating the audibility (or comfort or discomfort) of a complex signal.

It should be noted that, in all On-ear measurements, 1/3 octave band SPL is displayed (and reported when saving data to a file) at 1/12 octave frequencies which provides curve smoothing and causes the spectrum of narrow-band signals to appear broadened. When calculating overall rms from these data, the SPL at 225 Hz and subsequent 1/3 octave increments should be used.

Analysis of broad-band signals in all Test box tests, except Speechmap, is in 1/12 octave bands and the band SPL is displayed at 1/12 octave frequencies.

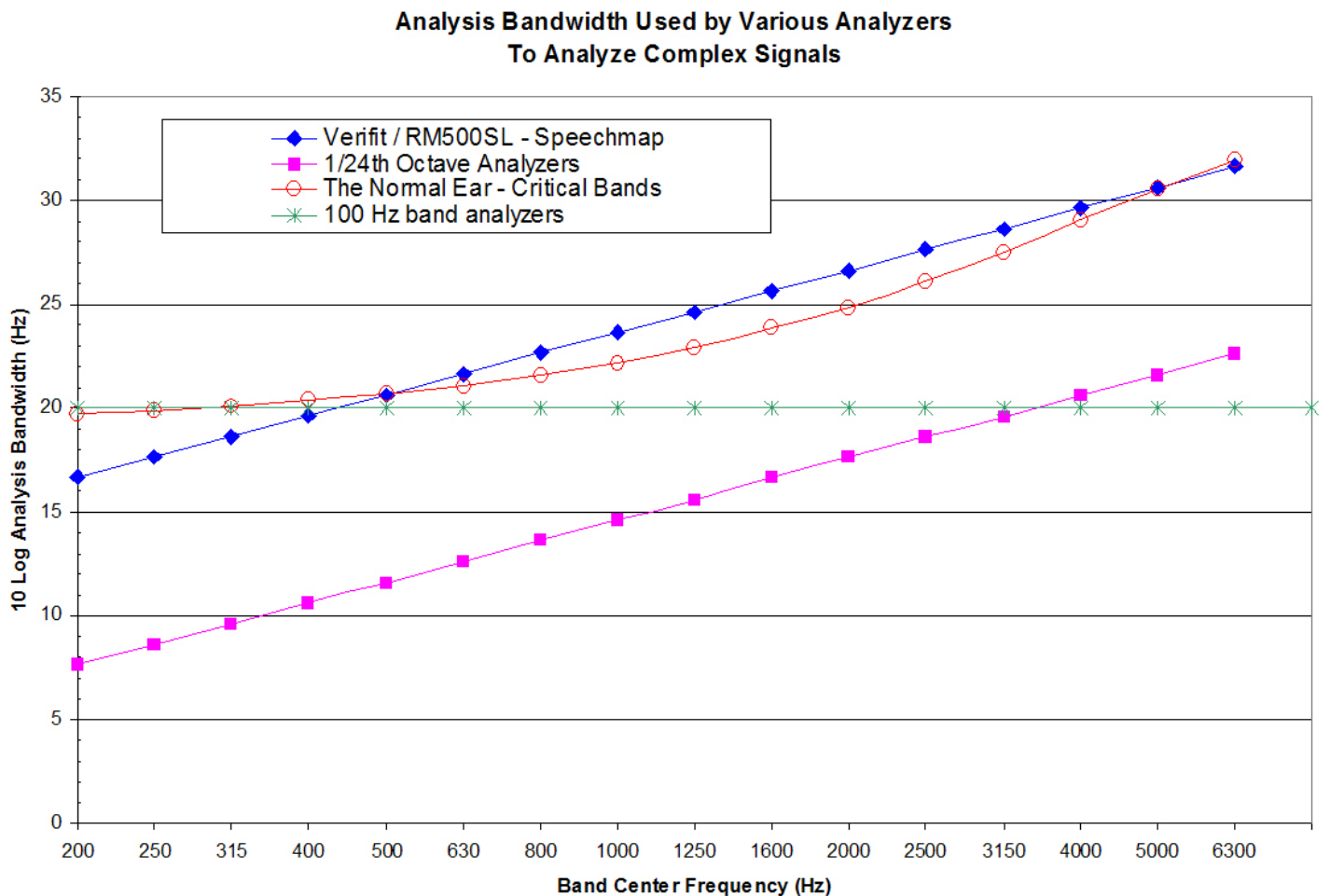

Figure 7: Analysis bandwidths of some real-ear analyzers and critical bands for a normal ear. If the analysis bandwidth is less than a critical band, aided response curves shown to be at threshold (or UCL) will actually be well above it.

### 3.1 Pink noise signal analysis

All band levels are calculated with an averaging time of 128 ms.

For a linear hearing aid, a pink noise stimulus will result in a response curve that has the same shape as one obtained using a swept pure tone. However, it must be remembered that, while a swept tone has the same band SPL as overall SPL, the band SPL for a noise signal is significantly lower than the overall SPL. Consequently, for a linear aid, output curves obtained using 1/12 octave analysis will be about 18 dB lower than the output curves obtained using a swept tone at the same overall SPL. As long as the hearing aid is linear, the gain obtained will be the same for both signals. Figure 8 shows output (A) and gain (B) for a linear hearing aid, obtained using a swept tone (1) and pink noise (2) with a 60 dB overall SPL.

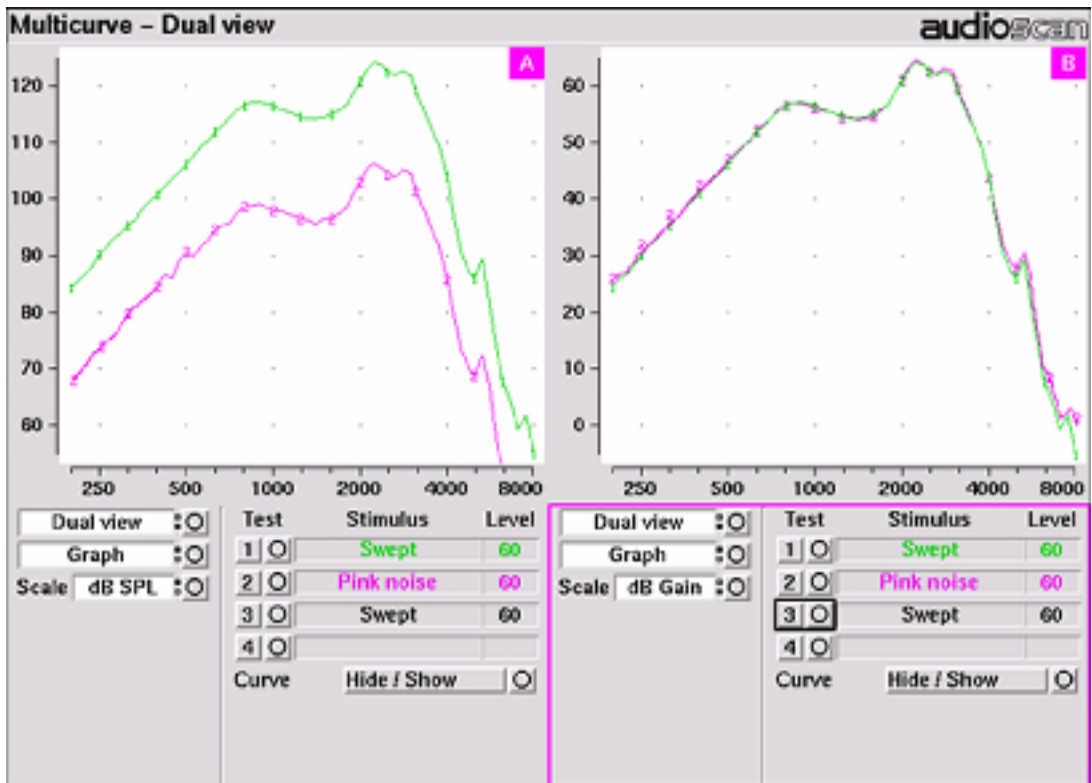

Figure 8: Output (left) and Gain (right) curves for a linear hearing aid, generated using a swept tone (1) and pink noise analyzed in 1/12 octave bands (2). (Dual view not available in RM500SL)

### 3.2 Real-speech signal analysis

One of the most-used measures of a speech signal is the long-term average speech spectrum (LTASS). This is a 1/3 octave spectrum averaged over a sufficiently long portion of the speech material to provide a stable curve. In practice a 10 second average meets this

requirement and, for this reason, all Speechmap passages are at least 10 seconds long. The LTASS curves displayed in Speechmap are 1/3 octave band levels at 1/12 octave intervals. It should be noted that this results in smoothing and the apparent broadening of the spectrum of a narrow-band signal. For example a 1/3 octave band of speech will exhibit a spectrum 2/3 octave wide.

The dynamic nature of speech is often characterized by the distribution of short-term levels in each 1/3 octave band. Historically, time periods of 120, 125 or 128 ms have been used. In Speechmap, 1/3 octave band levels at 1/12 octave intervals are derived every 128 ms. The level in each band that is exceeded by 1% of the samples (called L1, or 99th percentile) has historically been referred to as the speech peak for that band. The curve for these L1 levels is approximately 12 dB above the

LTASS. The level in each band that is exceeded by 70% of the samples (called L70, or 30th percentile) has historically been called the valley of speech for that band. The curve for these L70 levels is approximately 18 dB below the LTASS. The region between these two curves is often called the speech region, speech envelope or speech "banana". The speech envelope, when derived in this way, has significance in terms of both speech detection and speech understanding.

Generally, speech will be detectable if the L1 level is at or near threshold. The Speech Intelligibility Index (SII) is maximized when the entire speech envelope (idealized as a 30 dB range) is above (masked) threshold. This will not be an SII of 100% (or 1) because of loudness distortion factors, but higher SII values will not produce significantly higher scores on most test material.

The speech-reception threshold (SRT) is attained when the LTASS is at threshold (approximately - depending on test material and the individual). These scenarios are shown in Figures 10 - 12 which follow.

It should be noted that analysis methods which use shorter time periods produce higher peak levels and significantly different speech envelopes. In order to produce results that can be directly compared to measures of threshold (and UCL), the analysis time period needs to approximate the integration time of the ear. Although this varies with frequency and individuals, a value between 100 - 200 ms is likely. The Verifit and RM500SL use a 128 ms analysis time period as an approximation because it also has considerable historic support.

Because the spectrum of a speech signal varies with time, it is necessary to average measurements over

several seconds to obtain a stable, repeatable result. However, the effects of adjustments to hearing aid parameters need to be seen quickly in order to be useful for optimization. To resolve these conflicting needs, speech signals are first presented in a repeating loop with a sound-field equalization test prior to the start of each passage. A running calculation of the short-term speech envelope and average is performed on 2 - 3 seconds worth of data and is displayed in real time so that the effects of adjustments to hearing aid parameters are easily viewed. Pressing the Continue key causes the passage to restart and run in its entirety. The envelope and average are calculated over the full passage to provide stable and repeatable data.

When using live speech as a test signal, a "Freeze curve" function is available to capture the short-term spectra for examination and counseling purposes.

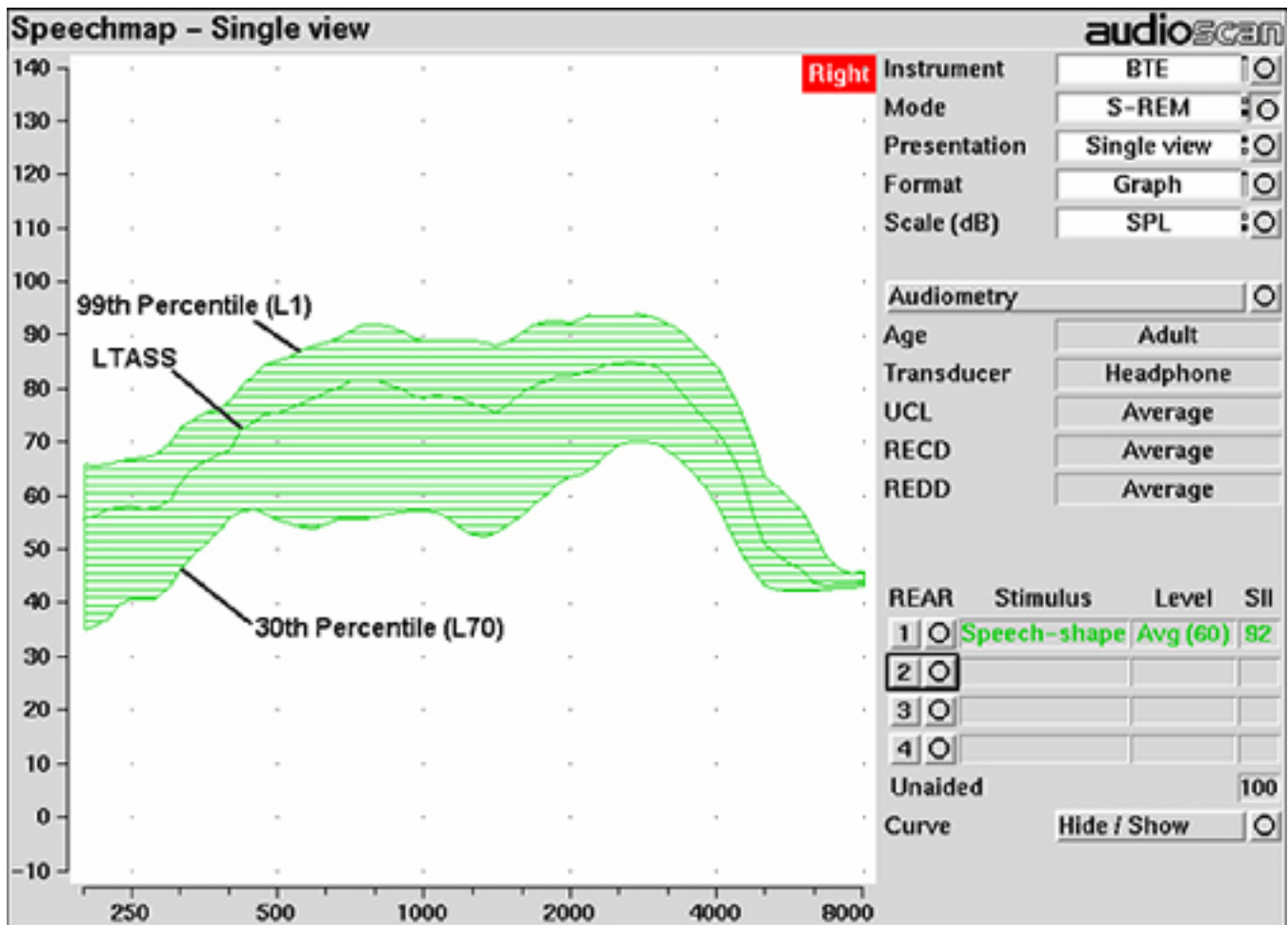

Figure 9: Example of speech envelope and LTASS



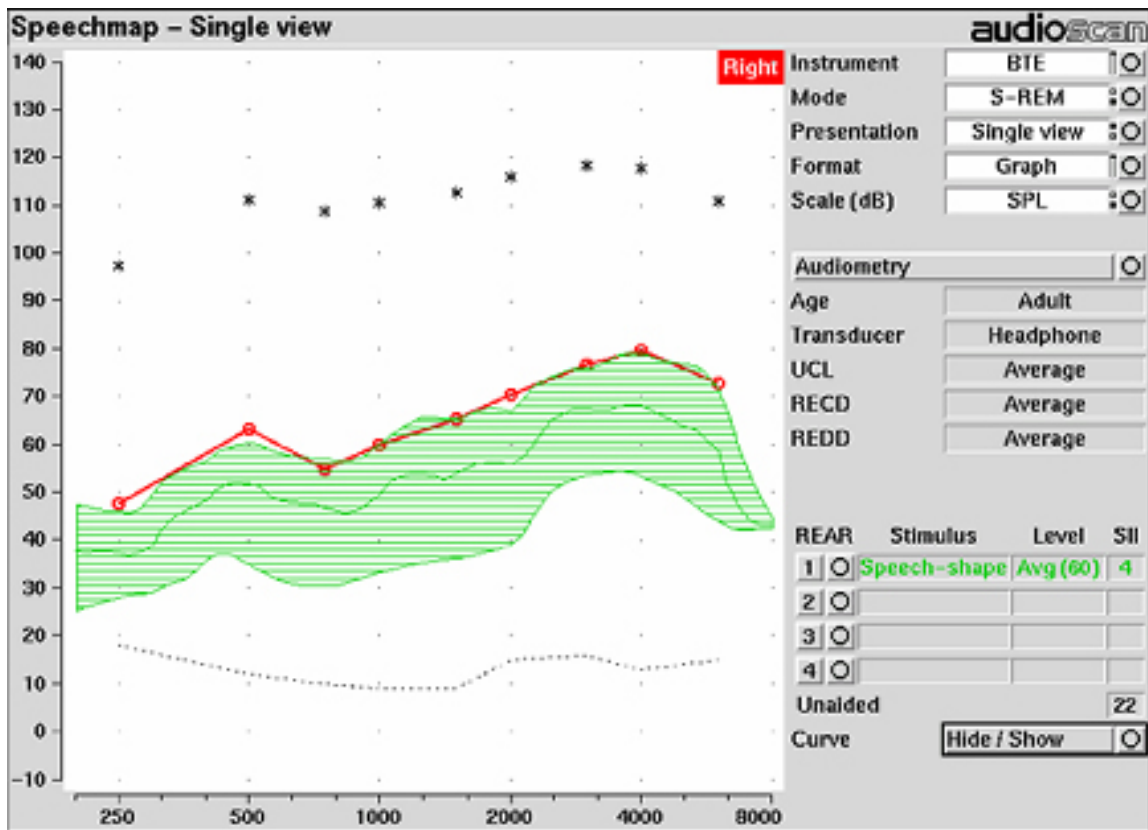

Figure 10: Speech is detectable but not understandable if the 99th percentile is at threshold

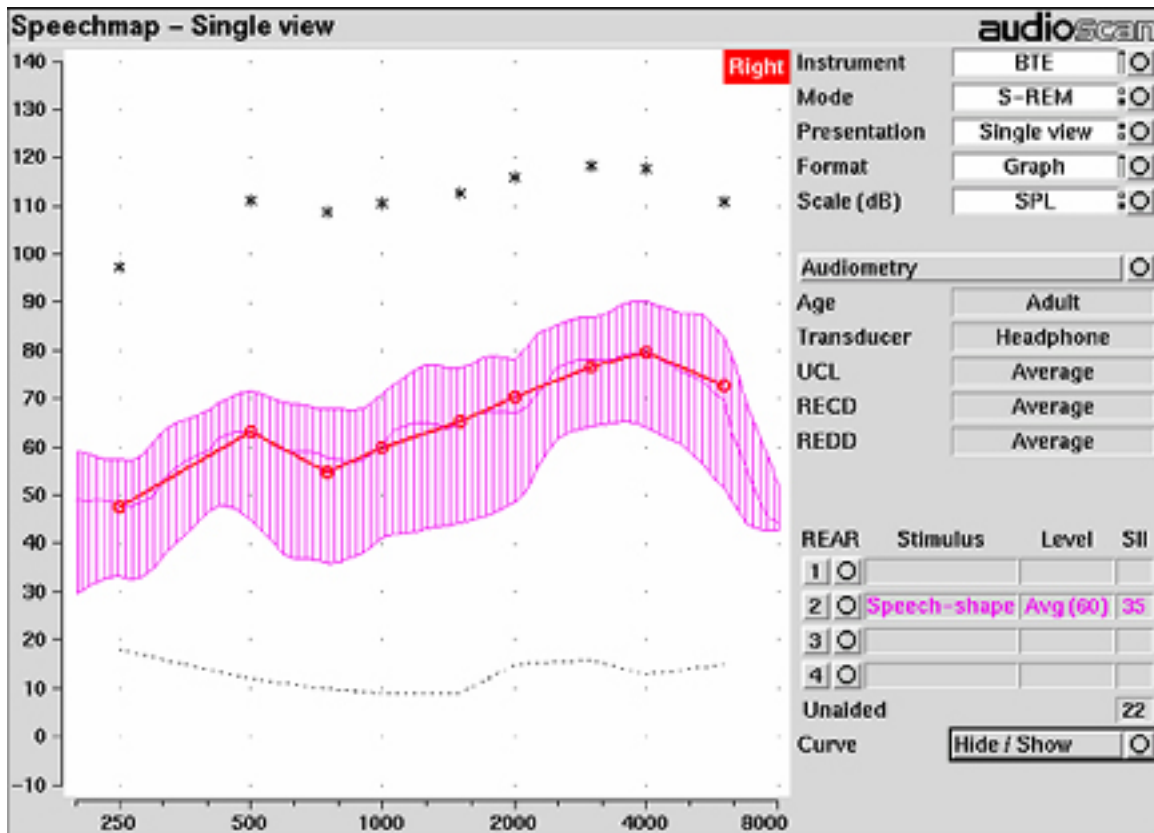

Figure 11: When LTASS is at threshold, SII  $\approx$  33% which corresponds approximately to SRT

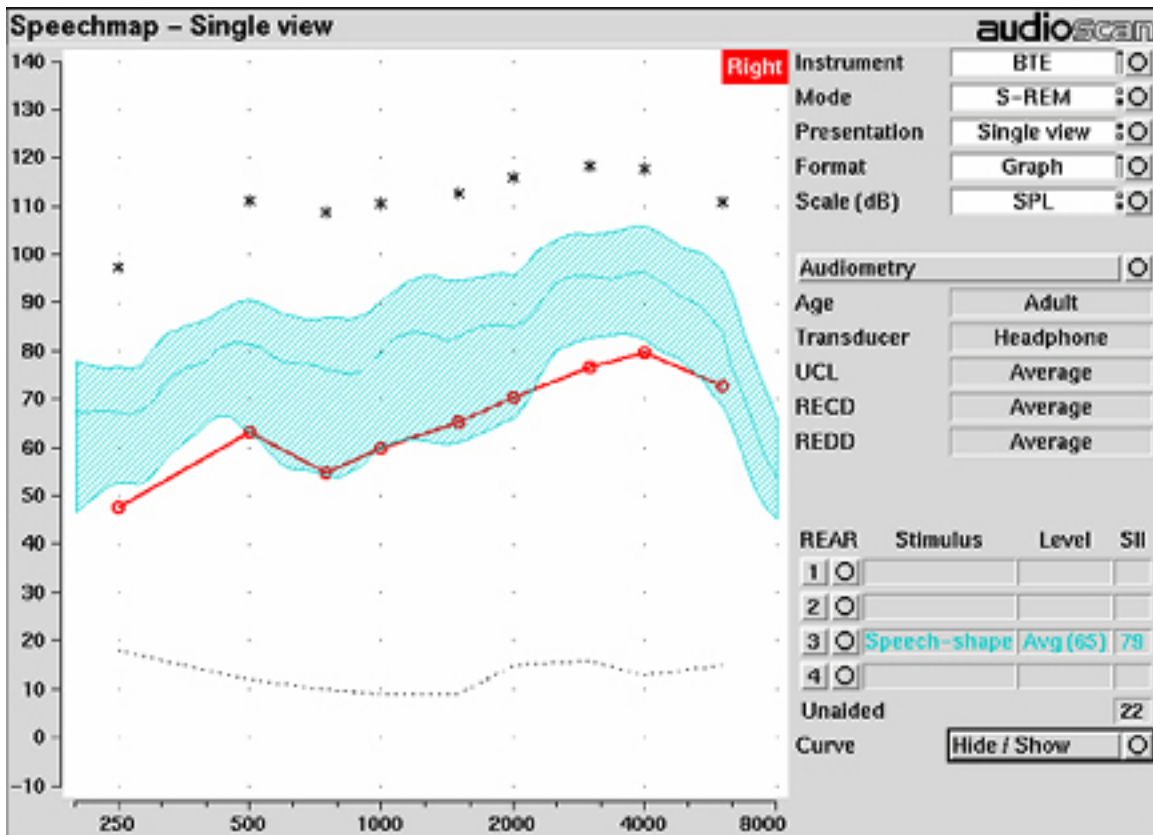

Figure 12: The highest SII is obtained when the entire speech envelope is above threshold

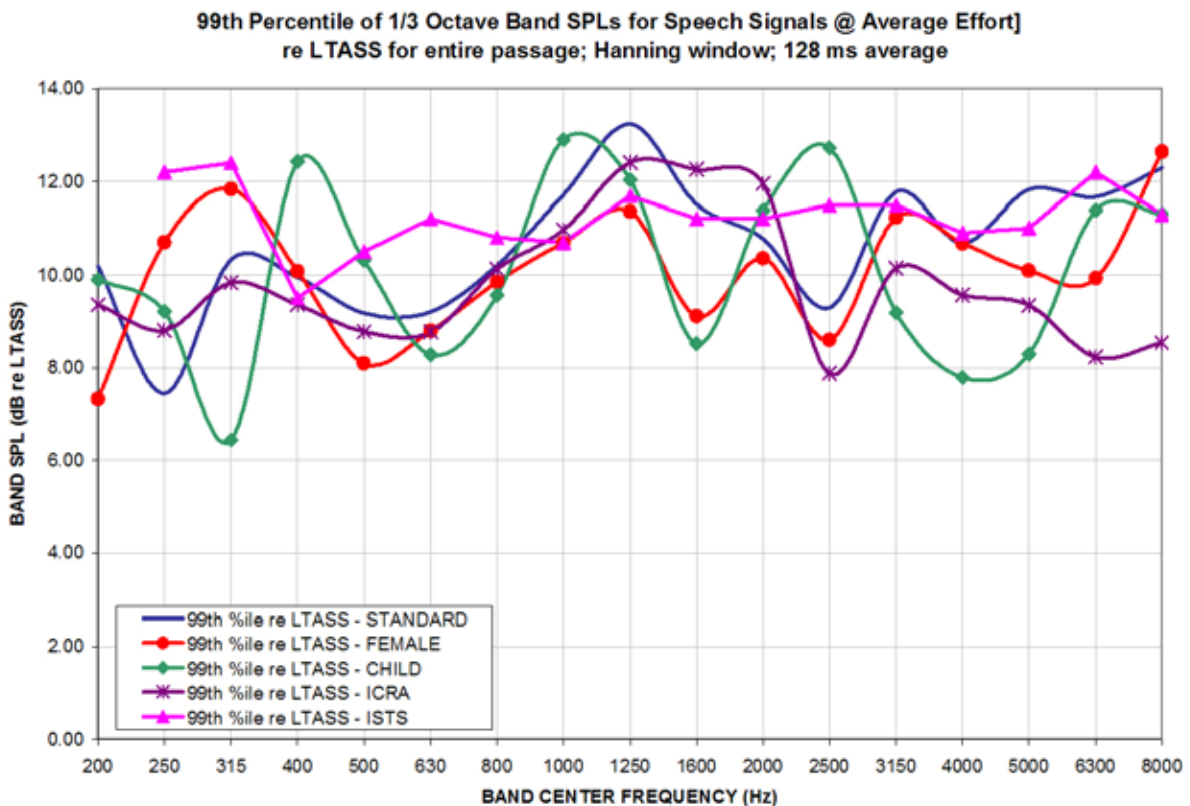

Figure 13: Level of 99th percentile for Speechmap speech signals at average vocal effort

